



goida-da.com

Hurry up for making children happy today, because tomorrow they will be adults

GOIDA®



Зробимо дітей щасливими сьогодні, адже завтра вони вже будуть дорослі

Ukraine, Dnipro  
info@goida-da.com



Період дитинства, який припадає лише 10% життя, формує його майбутнє. Від того, наскільки щасливими та здоровими ростуть діти, багато в чому залежить добробут суспільства. Адже принципи та правила поведінки, отримані в ранньому віці, стануть основою його переконань та дій у дорослому житті.

У прагненні зробити навколишній світ кращим і піклуватися про підрастаюче покоління, ми завжди готові стати Вашим надійним партнером.

Цим каталогом наша компанія представляє оновлений асортимент продукції. Він допоможе у пошуку оптимального рішення для організації спортивного та дитячого майданчика.

Ми бажаємо щастя вам!

**Павло Кільовий та Ольга Кільова**

The childhood period, which accounts for only 10% of a person's life, builds their future. The well-being of society largely depends on how happy and healthy children grow up. After all, the principles and rules of behavior acquired at an early age will become the basis of their beliefs and actions in adulthood.

In an effort to make the world a better place and take care of the younger generation, we are always ready to become your reliable partner.

With this catalog, our company presents an updated product range. It will help you find the best solution for organizing a sports ground and playground.



















We wish you happiness!

**Pavlo Kilovyi Olha Kilova**





## Пояснення до характеристик моделей/ Explanation of the characteristics of the models

 Артикул моделі/Model article number	 Пофарбована чи оцинкована сталь/ Painted or galvanized steel
 Модель для людей з обмеженими можливостями/A model for people with disabilities	 Нержавіюча сталь/Stainless Steel
 Габарити моделі/Dimensions of the model	 Деревина/Wood
 Безпечна зона/Safe zone	 Бетон/Concrete
 Висота вільного падіння/Free fall height	 Плити з поліетилену високої щільності/ Plates made of high-density polyethylene
 Вікова група/Age group	 Панелі з HPL/Panels from HPL
 Максимальна кількість користувачів/ Maximum number of users	 Етилен-пропіленовий каучук/ Ethylene-propylene rubber
 Вага моделі/Weight of the model	 Склопластик/Fiberglass
 Висота гірки/The height of the slide	 Гумові гранули різної фракції/ Rubber granules of different fractions

## Пояснення до характеристик розділу/ Explanation of the characteristics of the section

 Конструкція містить оцинковану чи пофарбовану сталь/The structure contains galvanized or painted steel	 Використовуються канати зі сталевим сердечником/ Ropes with a steel core are used
 Конструкція або елементи з нержавіючої сталі/ Stainless steel structure or elements	 Конструкція має захисний верх/ The design has a protective top
 Конструкція має у складі панелі HDPE/ The construction consists of HDPE panels	 У комплекті моделі PP-тунелі/ The model of the PP-tunnel is included
 Конструкція має елементи, що обертаються/ The structure has rotating elements	 Конструкція має ланцюжки з нержавіючої сталі/ The design has stainless steel chains
 У конструкції є рухомі елементи/ The design has moving elements	 Сертифіковані гойдалки/Certified swings
 Анкерування поверхнєве та глибоке/ Anchoring is superficial and deep	 Модель має панелі з полікарбонату, захищені від впливу сонця/The model has polycarbonate panels protected from the sun
 У складі виробу є елементи з дерева/ The product contains elements made of wood	 Конструкція обладнана гірками-трубами з нержавіючої сталі/The construction is equipped with stainless steel pipe slides
 Використовуються оцинковані анкери/ Galvanized anchors are used	 В моделі використовується поверхня з кольорової гуми/The model uses a colored rubber surface
 Конструкція має у складі панелі з полікарбонату/ The construction consists of polycarbonate panels	 Деталі з дерева акації/ Details of robinia wood
 У складі моделі гірки з нержавіючої сталі/ The model includes slides made of stainless steel	<ul style="list-style-type: none"> <li>Варіанти заміни матеріалів під час виготовлення моделі/Options for replacing materials during model manufacturing</li> </ul>

## Розділи

Ігрове обладнання для дитячих майданчиків та садків/ Play equipment for playgrounds and kindergartens	5
Тематичне обладнання для дитячих майданчиків/ Thematic equipment for playgrounds	36
Дитячі ігрові комплекси/ Children's playground complexes	54
Канатні комплекси/ Rope complexes	116
Серія Еко/ Eco series	132
Спортивне обладнання дитячих майданчиків/ Sports equipment for playgrounds	150
Вуличні тренажери та серія Street Workout/ Outdoor fitness equipment and Street Workout series	170
Обладнання для парку/ Park equipment	188
Обладнання для виходу та тренування собак/ Equipment for walking and training dogs	212
Ексклюзивні та типові проекти/ Exclusive and standard projects	218
Про компанію «Гойда»/ About the company «Goida»	236



# Каруселі/Carousels

Установка дитячої каруселі - чудовий варіант створити ігровий простір для малюків. Діти люблять швидкість, що дарує катання на каруселі, а також можливість проводити час у грі з друзями.

Яскрава барвиста карусель на майданчику миттєво покращує ігровий ландшафт. До того дитяча вулична карусель часто стає центром ігрової зони. Навколо неї вишиковується весь розважальний комплекс для дітей.

Installing a children's carousel is a great option to create a play space for kids. Children love the speed of riding a carousel, as well as the opportunity to spend time playing with friends.

A bright, colorful carousel on the playground instantly improves the play landscape. In addition, a children's outdoor carousel often becomes the center of the play area. The entire entertainment complex for children is lined up around it.



*Тойда-да, Тойда-да!,  
На майданчиках гра,  
Тойдаються дітки,  
Як яскраві квітки!*

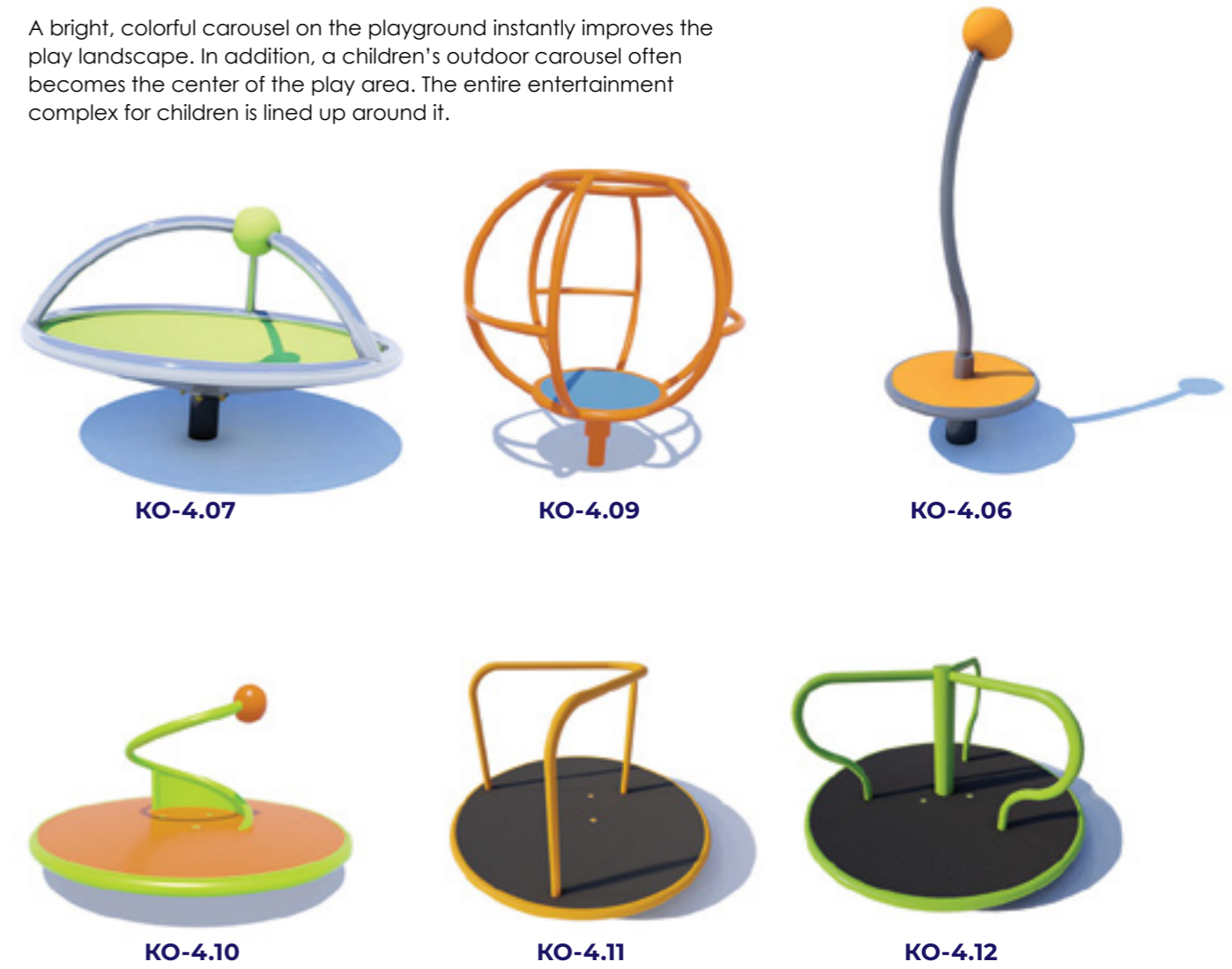

	A	♿	📏	📐	⏱️	👤	👥	📊	🔲	🔳	🌳	HDPE	RUBBER EPDM
KO-4.06	-	0,5x0,5x1,5	20,2	< 0,6	3-12	2	68	●	○	-	-	-	●
KO-4.07	-	1,2x1,2x0,9	21,0	0,9	3-12	3	88	●	○	-	-	-	●
KO-4.09	-	0,99x0,93x1,3	19,6	1,3	3-12	2	75	●	○	-	-	-	●
KO-4.10	-	1,5x1,5x0,68	23,75	< 0,6	3-12	4	105	●	○	-	-	-	●
KO-4.11	-	1,5x1,5x0,92	23,75	0,92	3-12	4	109	●	○	-	-	-	●
KO-4.12	-	1,5x1,5x0,79	23,75	0,83	3-12	4	113	●	○	-	-	-	●



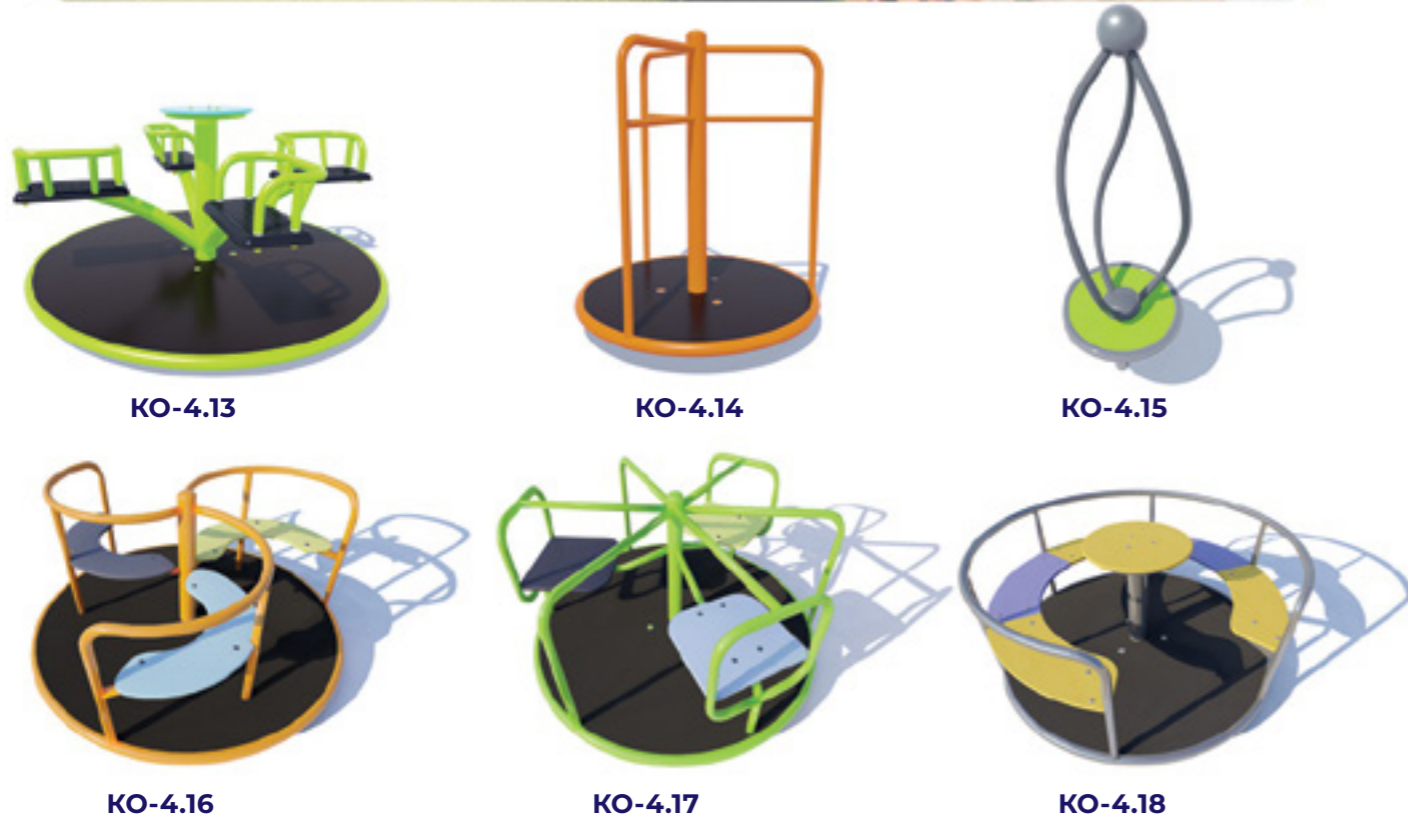

	A	♿	📏	📏	👤	👤+	⚖️	■	■	🌳	HDPE	RUBBER EPDM
KO-4.13	-	1,7x1,7x0,84	25,5	0,85	3-12	4	181	●	○	-	-	●
KO-4.14	-	1,0x1,0x1,15	19,6	1,16	3-12	3	88	●	○	-	-	●
KO-4.15	-	0,52x0,52x1,59	16,0	< 0,60	3-12	2	60	●	○	-	-	●
KO-4.16	-	1,5x1,5x0,76	31,3	0,76	3-12	3	128	●	○	●	○	●
KO-4.17	-	1,5x1,5x0,76	31,3	0,76	3-12	3	136	●	○	●	○	●
KO-4.18	-	1,5x1,5x0,71	31,3	0,71	3-12	6	143	●	○	●	○	●

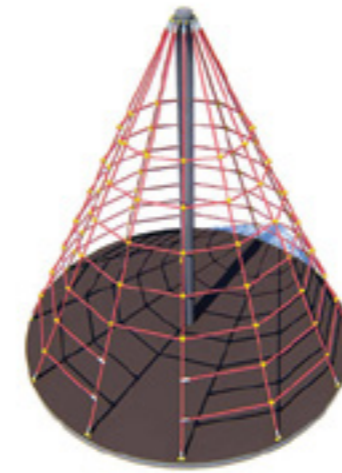

KK-11.17



KK-11.32

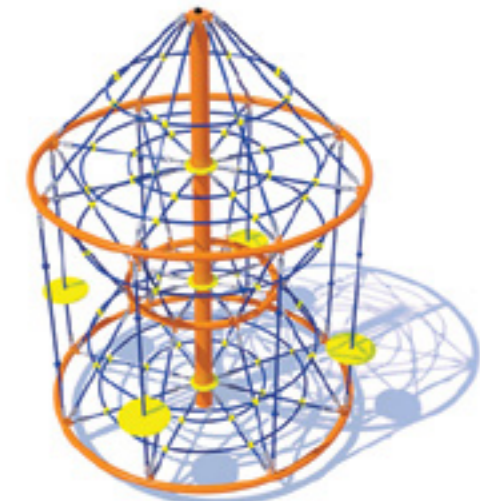

KK-11.46

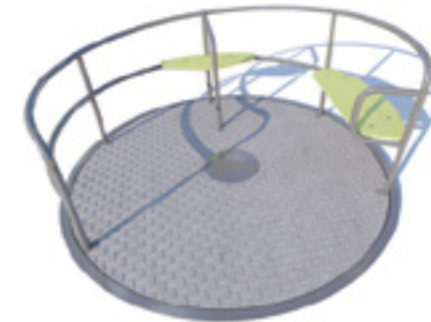

IN-12.31



KO-4.19  
Переносна модель / Portable model



	A	♿	📏	📏	👤	👤+	⚖️	■	■	🌳	HDPE	RUBBER EPDM
KK-11.17	-	2,39x2,39x2,3	32,1	2,0	7-14	8	248	●	-	-	-	●
KK-11.32	-	1,8x1,8x2,63	36,4	2,5	7-14	8	331	●	-	-	-	●
KK-11.46	-	2,0x2,0x2,94	38,4	2,0	7-14	8	151	●	-	-	-	-
IN-12.31	●	1,9x1,9x0,8	38,4	0,8	3-12	2	262	●	○	●	○	-
KO-4.19	-	0,85x0,85x0,35	18,4	< 0,6	3-12	3	17	●	-	●	-	-

ХАРАКТЕРИСТИКИ РОЗДІЛУ КАРУСЕЛІ / CHARACTERISTICS OF THE CAROUSELS SECTION

- Деталі з нержавіючої сталі / Stainless steel elements
- Деталі з оцинкованої сталі / Galvanised steel construction
- Обертові елементи / Spinning elements
- HDPE панелі / HDPE panels

o - опція/option

- Анкерування:
  - Поверхнєве
  - Глибоке
- Anchoring:
  - Surface
  - Deep

\* Варіанти матеріалів стосуються вибраних продуктів, для отримання додаткової інформації відвідайте [www.goida-da.com](http://www.goida-da.com)  
 \* Material options apply to selected products, for more information visit [www.goida-da.com](http://www.goida-da.com)



# Альтанки, будинки / Play cabins

Будиночки-альтанки стануть відмінною прикрасою для ігрового майданчика або двору, садка або школи. Діти зможуть не тільки весело провести час, але й сховатися від дощу чи сонця.

Gazebo houses will be a great decoration for a playground or yard, kindergarten or school. Children will be able not only to have fun time, but also hide from the rain or sun.



DB-4.01\*



DB-4.01.1\*



DB-4.03\*



DB-4.04\*



DB-4.06\*



DB-4.07



DB-4.11\*



DB-4.09



Model	Dimensions	Area	Height	Age	Capacity	Weight	Material 1	Material 2	Material 3	Material 4	Material 5	Material 6
DB-4.01	1,45x1,49x2,07	29,9	< 0,6	3-12	6	129	●	-	●	-	-	-
DB-4.01.1	1,45x1,49x2,07	29,9	< 0,6	3-12	6	147	●	-	●	-	-	-
DB-4.03	5,0x2,6x2,7	59,4	< 0,6	3-12	10	877	●	-	●	-	-	-
DB-4.04	3,3x2,4x2,7	46,7	< 0,6	3-12	6	514	●	-	●	-	-	-
DB-4.06	2,0x1,2x2,1	31,2	< 0,6	3-12	3	196	●	-	●	-	-	-
DB-4.07	2,1x1,1x1,9	31,1	< 0,6	3-12	4	155	●	-	●	-	-	-
DB-4.09	2,96x1,4x2,3	36,4	< 0,6	1-6	3	310	●	-	●	-	-	-
DB-4.11	6,5x4,83x2,8	92,7	< 0,6	1-6	20	1011	●	-	●	-	-	-



TN - 4.02\*



IN - 12.02\*



DB-4.08\*



Model	Dimensions	Area	Height	Age	Capacity	Weight	Material 1	Material 2	Material 3	Material 4	Material 5	Material 6
TN-4.02	9,0x6,1x3,87	80,3	< 0,6	1-6	35	2450	●	-	●	-	-	-
IN - 12.02	7,0x3,0x2,7	77	< 0,6	1-6	5	984	●	-	●	-	-	-
DB-4.08	4,2x3,5x3,0	61,5	< 0,6	1-6	8	472	●	-	●	-	-	-

\*Конструкції тінювих навісів, при бажанні замовника, індивідуально комплектуються різноманітними матеріалами, такими як бітумна та металева черепиця, сотовий або монолітний полікарбонат. Можливе брендове фарбування та, за необхідністю, зміна розмірів.

\*At the customer's request, shade canopy structures can be individually equipped with a variety of materials, such as bituminous and metal tiles, cellular or monolithic polycarbonate. Branded painting and, if necessary, resizing is possible.





## Пісочниці/Sandboxes

Пісочниці є одним із найпопулярніших елементів дитячих майданчиків. Цікавий дизайн, яскраві кольори обов'язково сподобаються дітям та прикрасять будь-яку ігрову зону. Борти пісочниць виконані з якісної деревини та пофарбовані безпечною акриловою фарбою.

Sandboxes are one of the most popular elements of children's playgrounds. Interesting design, bright colors are sure to appeal to children and will decorate any play area. The sides of the sandboxes are made of high-quality wood and painted with safe acrylic paint.

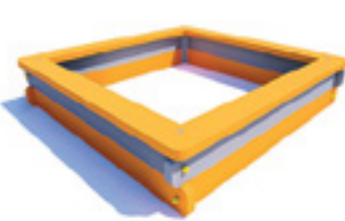

PO-4.02

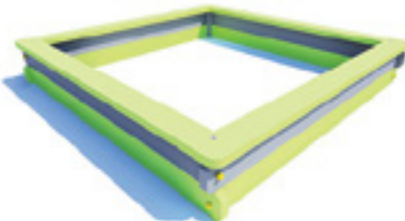

PO-4.03

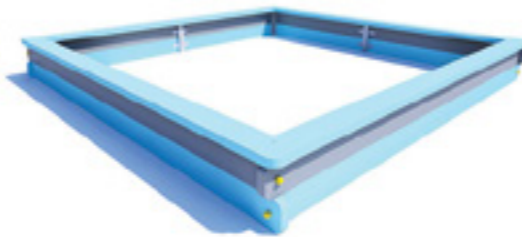

PO-4.04



PO-4.10



PO-4.19



Model	Color	Dimensions (LxWxH)	Area (m²)	Weight (kg)	Age Group	Capacity	Material 1	Material 2	Material 3	Material 4	Material 5
PO-4.02	-	1,5x1,5x0,32	18	<0,6	1-6	2	59	●	-	●	-
PO-4.03	-	2,0x2,0x0,32	36	<0,6	1-6	3	78	●	-	●	-
PO-4.04	-	2,9x2,9x0,32	47	<0,6	1-6	5	124	●	-	●	-
PO-4.10	-	2,15x1,57x1,74	34,2	<0,6	1-6	2	96	●	-	●	-
PO-4.19	-	3,84x2,78x2,2	53,1	<0,8	1-6	5	267	●	●	●	●







PO-4.11



PD-4.01



PO-4.12



PO-4.14

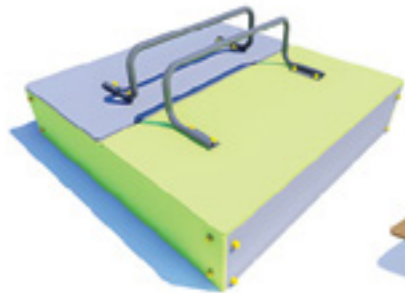

PO-4.16



PO-4.18



Model	Dimensions (LxWxH)	Weight (kg)	Height (m)	Age Group	Capacity	Weight (kg)	Material 1	Material 2	Material 3	Material 4	Material 5	Material 6	Material 7	Material 8
PD-4.01	4,6x3,4x2,8	78,4	0,9	1-6	7	399	0,9	●	●	●	-	-	-	-
PO-4.11	1,5x1,5x2,2	30,2	< 0,6	1-6	2	140	-	●	-	●	-	-	-	-
PO-4.12	1,85x1,83x1,6	34,1	< 0,6	1-6	3	95	-	●	-	●	-	-	-	-
PO-4.14	2,5x2,5x1,6	42,2	< 0,6	1-6	5	149	-	●	-	●	-	-	-	-
PO-4.16	1,5x1,5x0,56	30,2	< 0,6	1-6	2	69	-	●	-	●	-	-	-	-
PO-4.18	4,34x1,36x0,32	40	< 0,6	1-6	23	93	-	●	-	●	-	-	-	-



PD-4.03



PD-4.04



Model	Dimensions (LxWxH)	Weight (kg)	Height (m)	Age Group	Capacity	Weight (kg)	Material 1	Material 2	Material 3	Material 4	Material 5	Material 6	Material 7	Material 8
PD-4.03	5,5x4,04x2,6	76,3	1,2	1-6	10	482	0,6	●	-	●	-	-	-	-
PD-4.04	5,9x4,65x3,9	85,6	1,2	1-6	12	601	0,6	●	-	●	-	-	-	-





IN - 12.17

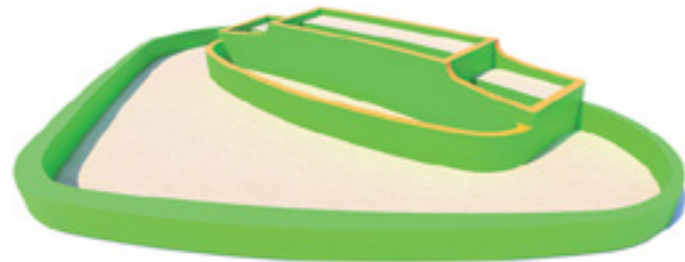

IN - 12.27

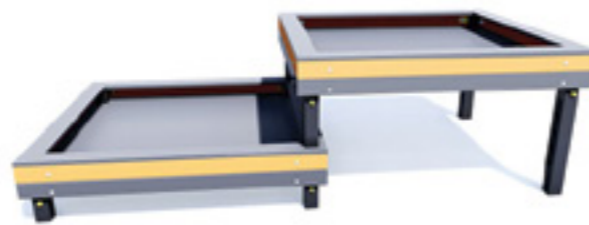

IN - 12.28



	A	♿	📺	📺	📺	👤	👤	📊	📊	📊	HDPE	🚚
IN - 12.17	●	●	●	●	●	●	●	●	●	●	●	●
IN - 12.27	●	●	●	●	●	●	●	●	●	●	●	●
IN - 12.28	●	●	●	●	●	●	●	●	●	●	●	●







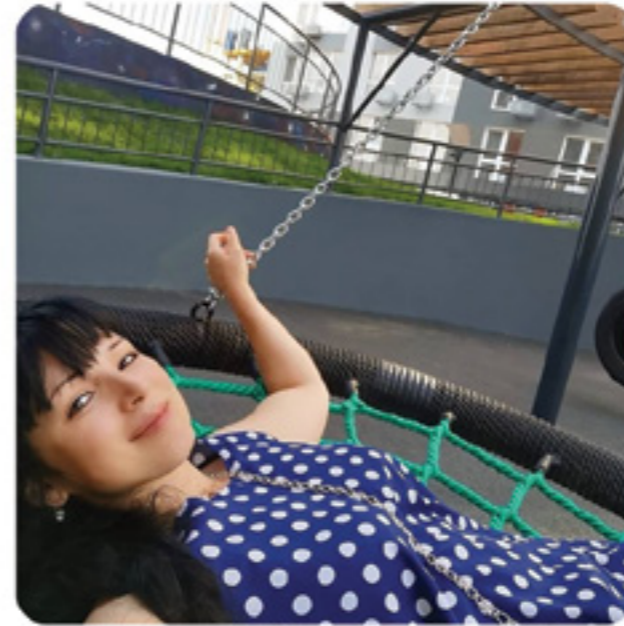

KM-4.26\*



KM-4.28\*

	A	♿	📖	🏠	📏	👤	👤+	📊	●	○	-	-	-
KM-4.26	-				1,45	6+	12	665	●	○	-	-	-
KM-4.28	-				1,45	6+	18	945	●	○	-	-	-

\*Конструкція даних моделей дозволяє комплектування різними видами підвісів.  
 \*Constructions of these models allows for the completion of various types of suspensions.



## Гойдалки-балансири / Balancer swings

Гойдалка-балансир – невідтний елемент та прикраса ігрового майданчика, яка принесе малюкам масу задоволення. Це – горизонтальна планка, яка кріпиться по центру до спеціальної стійки. З двох боків облаштовані сидіння із ручками. Наводиться гойдалка в рух шляхом зусиль не одного, а двох дітей. Тому напружуються навички досягнення мети у команді, відбувається навчання співпраці. Розвивається товарицькість, оскільки дітям доводиться спільно діяти. Крім того, тренуються м'язи, розвивається координація руху та вестибулярний апарат.

A swing-balancer is an integral element and decoration of the playground that will bring a lot of fun to kids. It is a horizontal bar that is attached in the center to a special stand. There are seats with handles on both sides. The swing is set in motion by the efforts of not one, but two children. Therefore, the skills of achieving a goal in a team are developed, and cooperation is taught. Sociability develops as children have to work together. In addition, muscles are trained, coordination and vestibular apparatus.



KB-4.01

KB-4.02



KB-4.05



KB-4.03



KB-4.01	-	2,48x0,36x0,6	28,3	< 0,8	3-12	2	43	●	-	●	-	-
KB-4.02	-	2,24x0,36x0,7	27,2	< 0,8	3-12	2	41	●	-	●	-	-
KB-4.03	-	2,5x0,36x0,8	28,3	< 0,8	3-12	2	45	●	-	●	-	-
KB-4.05	-	2,3x0,37x0,7	27,4	< 0,8	3-12	2	38	●	○	●	○	-





## Гойдалки на пружині / Spring rocking toys

Гойдалки на пружині – обладнання, яке поживає дитячий майданчик і є улюбленим ігровим елементом для найменших. Їх встановлюють у дворах будинків, у дитячих садках та на присадибних або дачних ділянках. Чим цікавіше оформлена гойдалка, тим більше вона привертає увагу не тільки малюків, але й старших дітях, тим цікавіше на ній грати.

A swing on a spring is an equipment that enlivens the playground and is a favorite play element for the little ones. They are installed in the yards of houses, in kindergartens and on personal or summer cottages. The more interesting the swing is designed, the more it attracts the attention of not only kids, but also older children, the more interesting it is to play on it.

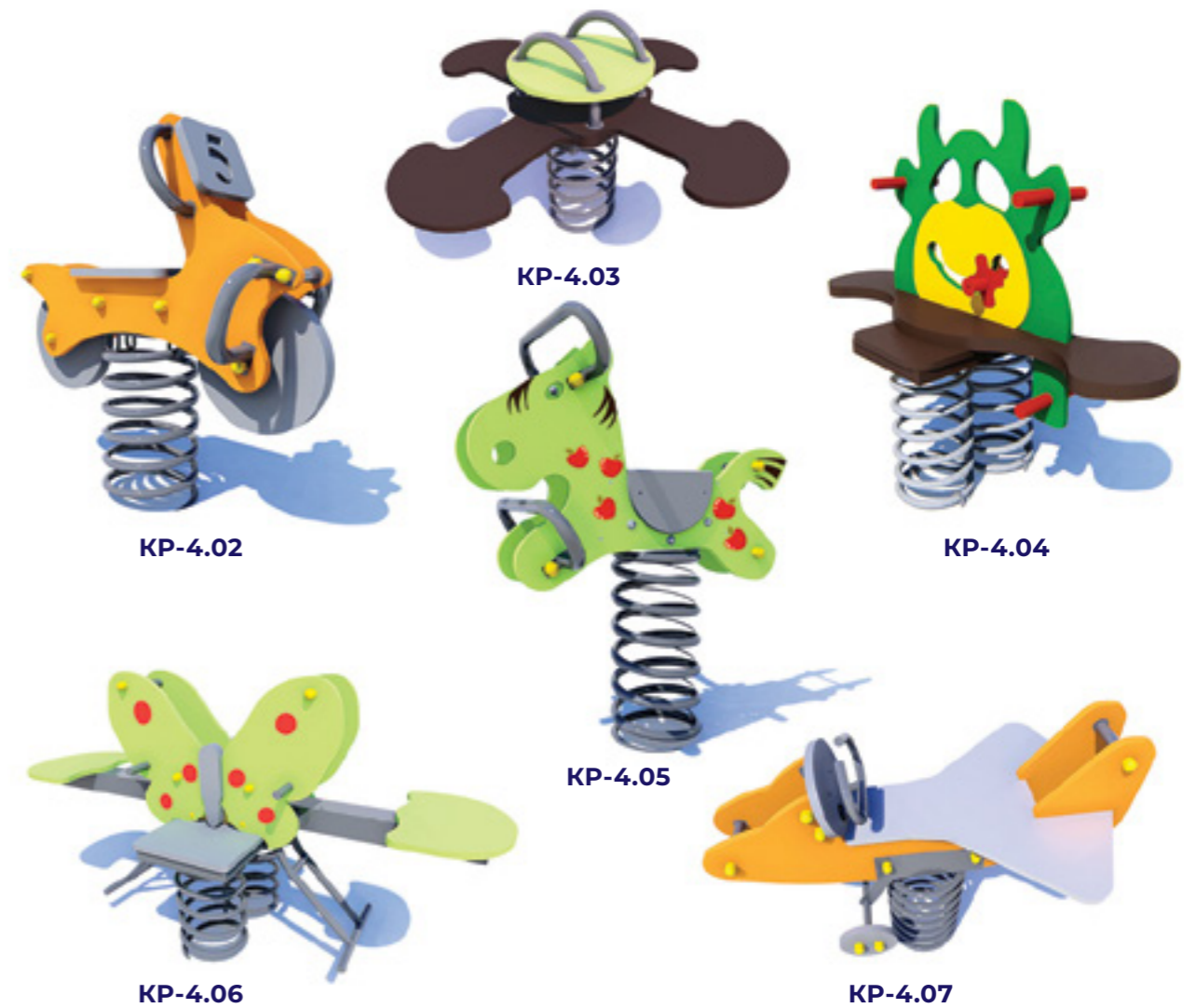
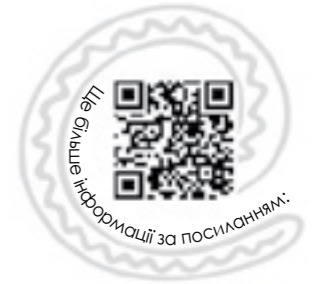

	A	♿	📖	📏	📏	👤	👤	📊	📏	📏	📏	HDPE	HPL
KP-4.02	-	0,85x0,42x0,95	11	< 0,6	3-6	1	38	●	-	●	○	-	-
KP-4.03	-	1,2x1,2x0,7	15	< 0,6	3-6	4	37	●	-	●	-	-	-
KP-4.04	-	1,25x0,6x1,06	11	< 0,6	3-6	2	75	●	-	●	-	-	-
KP-4.05	-	0,9x0,4x1,05	11	< 0,6	3-6	1	43	●	-	●	○	-	-
KP-4.06	-	1,6x0,6x0,9	15	< 0,6	3-6	2	103	●	-	●	-	-	-
KP-4.07	-	0,98x0,58x0,83	11	< 0,6	3-6	1	46	●	-	●	○	-	-





КР-4.08



КР-4.09



КР-4.10



КР-4.12



КР-4.16



КР-4.24



КР-4.25



КР-4.26



Model	Dimensions (LxWxH)	Area (m²)	Height (m)	Age Group	Capacity	Weight (kg)	Material 1	Material 2	Material 3	Material 4	Material 5
КР-4.08	0,82x0,47x0,8	11	< 0,6	3-6	1	45	●	-	●	-	-
КР-4.09	0,75x0,46x0,9	11	< 0,6	3-6	1	47	●	-	●	-	-
КР-4.10	0,9x0,47x0,9	11	< 0,6	3-6	1	56	●	-	●	-	-
КР-4.12	0,59x0,5x0,82	11	< 0,6	3-6	1	44	●	-	●	-	-
КР-4.16	1,26x0,73x1,49	15	< 0,6	3-6	2	107	●	-	●	-	-
КР-4.24	1,1x0,6x0,95	15	0,8	3-6	1	67	●	-	●	-	-
КР-4.25	0,85x0,69x1,33	15	1,5	3-6	2	107	●	○	●	○	-
КР-4.26	1,09x0,63x1,04	15	0,8	3-6	1	79	●	-	●	○	-



КР-4.28



КР-4.29



КР-4.30



КР-4.32



Model	Dimensions (LxWxH)	Area (m²)	Height (m)	Age Group	Capacity	Weight (kg)	Material 1	Material 2	Material 3	Material 4	Material 5
КР-4.28	1,16x0,44x1,28	30	< 0,60	3-6	2	39	●	○	●	○	-
КР-4.29	2,76x0,54x1,08	30,6	< 0,60	3-6	2	88	●	○	●	○	-
КР-4.30	0,81x0,42x0,94	21,2	< 0,60	3-6	1	32	●	○	●	○	-
КР-4.32	1,65x1,57x0,52	31,5	< 0,60	3-6	4	112	●	-	●	-	-

ХАРАКТЕРИСТИКИ РОЗДІЛІВ «ГОЙДАЛКИ» / CHARACTERISTICS OF «SWING» SECTIONS

<p>Конструкція або елементи з нержавіючої сталі Stainless steel construction or elements</p>	<p>Конструкція містить оцинковану чи пофарбовану сталь The structure contains galvanized or painted steel</p>	<p>Дерев'яна конструкція Wood construction</p>	<p>Анкери оцинковані Galvanized anchors</p>	<p>Ланцюжки з нержавіючої сталі Stainless steel chains</p>
<p>Сертифіковані гойдалки Certified swing seats</p>	<p>Міцні роз'єми Durable connectors</p>	<p>Захисний верх Protective tops</p>	<p>Канати зі сталевим сердечником Ropes with steel core</p>	
<p>Конструкції: ● Пофарбована сталь ● Нерж. сталь ● Пофарбоване дерево</p>	<p>Анкерування: - Поверхня - Глибока</p> <p>Anchoring: - Surface - Deep</p>			

\* Варіанти матеріалів стосуються вибраних продуктів, для отримання додаткової інформації відвідайте [www.goida-da.com](http://www.goida-da.com)

\* Material options apply to selected products, for more information visit [www.goida-da.com](http://www.goida-da.com)



## Гірки/Slides

Гірки будуть чудовою прикрасою для кожного дитячого майданчика. Гірки можуть бути не тільки гарним місцем для відпочинку, але й корисним атрибутом для покращення навичок дитини та відмінним атрибутом для підняття настрою.

Slides will be a great decoration for every playground. Slides can be not only a good place to relax, but also a useful attribute to improve the child's skills and an excellent attribute to raise the mood.

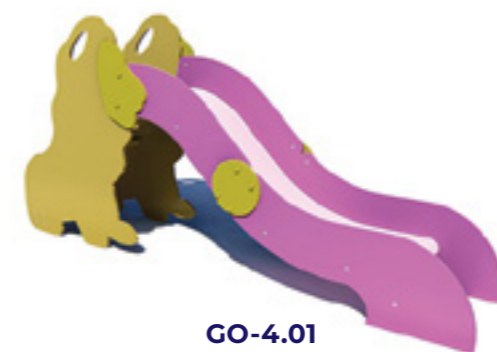

GO-4.01

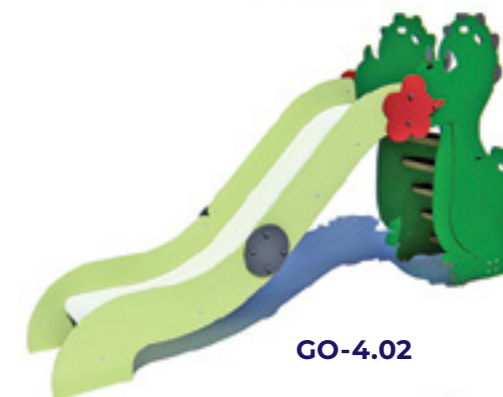

GO-4.02



GO-4.04



GO-4.03

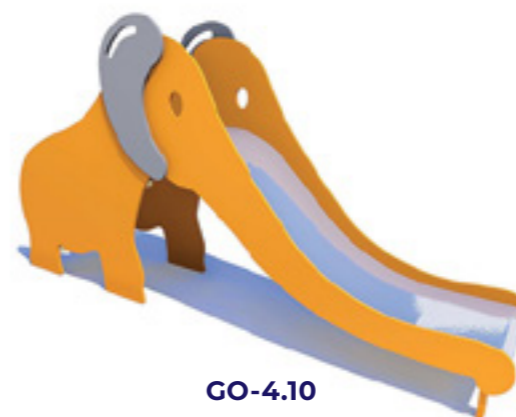

GO-4.10



GO-4.11



GO-4.01	-	2,9x0,56x1,4	31,3	0,9	3-12	1	87	0,9	●	●	●	○	-
GO-4.02	-	3,5x0,56x1,8	34,1	1,2	3-12	1	98	1,2	●	●	●	○	-
GO-4.03	-	3,18x0,56x1,9	32,6	1,2	3-12	1	83	1,2	●	●	●	○	-
GO-4.04	-	3,1x0,56x1,36	32,3	0,9	3-12	1	113	0,9	●	●	●	○	-
GO-4.10	-	2,83x0,56x1,6	31,4	0,9	3-12	1	113	0,9	●	●	●	○	-
GO-4.11	-	3,0x0,56x1,4	31,9	0,9	3-12	1	87	0,9	●	●	●	○	-



## Різновиди гірок із нержавіючої сталі / Varieties of stainless steel slides



Гірки з нержавіючої сталі будуть чудовою прикрасою для кожного дитячого майданчика. Вони можуть бути не тільки гарним місцем для відпочинку, але й корисним атрибутом для покращення навичок дитини та відмінним атрибутом для підняття настрою. Гірки з нержавіючої сталі товщиною 2 мм менш схильні до ефекту корозії за рахунок чого збільшується термін експлуатації.

Stainless steel slides will be a great decoration for every playground. They can be not only a good place to relax, but also a useful attribute to improve the child's skills and an excellent attribute to lift the mood. Slides made of stainless steel 2 mm are less susceptible to the effect of corrosion, due to which the service life increases.

### Увага! Види з'їздів з гірки / Attention! Types of descents from the slide

Із закругленням / With rounding

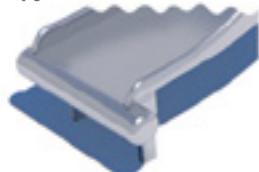

Прямий / Direct

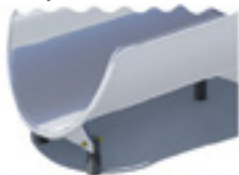

UPK-16.38.150 UPK-16.38.120 UPK-16.38.90 UPK-16.38.60



UPK-16.40



UPK-16.41



SB-1.2



SB-1.5



Model	A	B	C	D	E	F
UPK-16.38.150	-	-	3-12	1	1,5	•
UPK-16.38.120	-	-	3-12	1	1,2	•
UPK-16.38.90	-	-	3-12	1	0,9	•
UPK-16.38.60	-	-	3-12	1	0,6	•
UPK-16.40	-	-	3-12	1	3,5	•
UPK-16.41	-	-	3-12	1	2,4	•
SB-1.2	-	-	3-12	1	1,2	•
SB-1.5	-	-	3-12	1	1,5	•





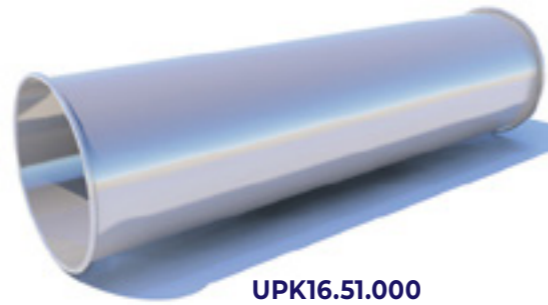

Code	Dimensions	Weight	Age	Capacity	Material	HDPE	HPL
UPK16.50.000	3,04x0,8x0,8	0,8	3-12	1	223	-	-
UPK16.51.000	3,0x0,8x0,8	0,8	3-12	1	223	-	-
UPK16.52.000	2,0x0,8x0,8	0,8	3-12	1	149	-	-

## Увага! Інноваційне покриття для металевих конструкцій/ Attention! Innovative coating for metal structures

### 5 причин для використання гумового покриття/5 reasons to use a rubber coating

Пластизоль, одна з найуніверсальніших технологій покриття металів, допомагає зробити дитячі майданчики настільки ж безпечними, як і цікавими. Ось кілька причин, через які пластизоль є відмінним промисловим покриттям для ігрового обладнання.

1. Пластизольне пластикове покриття витримує інтенсивний режим експлуатації і при цьому безпечно для дітей.
2. Пластикові покриття можна пофарбувати практично в будь-який колір веселки.
3. Пластизоль створений для того, щоб витримувати найсуворіші погодні умови. Покриття забезпечує захист від іржі та корозії довше, ніж шар фарби.
4. Як і будь-яке вуличне обладнання, ігрове обладнання потребує постійного обслуговування, щоб воно виглядало і функціонувало якнайкраще. Технічне обслуговування може виявитися значними витратами. Пластизоль значно їх скорочує.
5. Пластизольне покриття залишається більш прохолодним влітку і більш теплим взимку.

Plastisol, one of the most versatile metal coating technologies, helps to make children's playgrounds as safe as they are fun. Here are some reasons why plastisol is an excellent industrial coating for playground equipment.

1. Plastisol plastic coating withstands intensive use and is safe for children.
2. Plastic coatings can be painted in almost any color of the rainbow.
3. Plastisol I is designed to withstand the harshest weather conditions. The coating provides protection against rust and corrosion longer than a layer of paint.
4. Like any outdoor equipment, playground equipment requires ongoing maintenance to keep it looking and functioning at its best. Maintenance can be a significant expense. Plastisol significantly reduces them.
5. The plastisol coating stays cooler in summer and warmer in winter.

Платформа гірки\*/  
Slide platform\*



Сходи́нка гірки\*/  
Slide step\*



Code	Dimensions	Weight	Age	Capacity	Material	HDPE	HPL
GM-1.01	3,2x0,92x1,74	31,3	0,9	3-12	1	65	0,9
GM-1.02	3,6x0,92x2,04	31,3	1,2	3-12	1	76	1,2
GM-1.03	3,96x0,92x2,34	31,3	1,5	3-12	1	87	1,5
GM-1.04	4,3x0,92x2,64	31,3	1,8	3-12	1	96	1,8
GM-1.05	4,66x0,92x3,24	31,3	2,4	3-12	1	103	2,4
GM-1.06	4,2x2,0x3,24	31,3	2,4	3-12	1	144	2,4

\*Можливе комплектування цієї універсальної платформи та сходинок для різноманітних моделей гірок: із нержавіючої сталі, склопластикових гірок

\*It is possible to complete the platform and steps for various models of slides: made of stainless steel, fiberglass slides

Примітка. У вартість гірки не входить вартість платформи та розраховується окремо/

Note. The cost of the slide does not include the cost of the platform and is calculated separately





## Різновиди гірок зі склопластика / Types of fiberglass slides

Практично в кожному дворі є гірка - захопливий атракціон для дітей різного віку. Саме від його конструкції, якості, дизайну залежить комфорт і безпека маленьких користувачів. Склопластик – це композиційний матеріал, що складається зі скловолокна та сполучної речовини. Механічні властивості склопластику можна порівняти зі сталевими сплавами. Його переваги: невелика вага; стійкість до деформацій, гниття, розтріскування, займання. За будь-якої погоди вона залишається досить комфортною – не розжарюється на сонці та не зледеніє при екстремально низьких температурах.



Almost every yard has a slide, an exciting attraction for children of all ages. The comfort and safety of young users depends on its construction, quality, and design. Fiberglass is a composite material consisting of glass fiber and a binder. The mechanical properties of fiberglass are comparable to steel alloys. Its advantages are: light weight; resistance to deformation, rotting, cracking, and fire. In any weather, it remains quite comfortable - it does not heat up in the sun and does not freeze at extremely low temperatures.

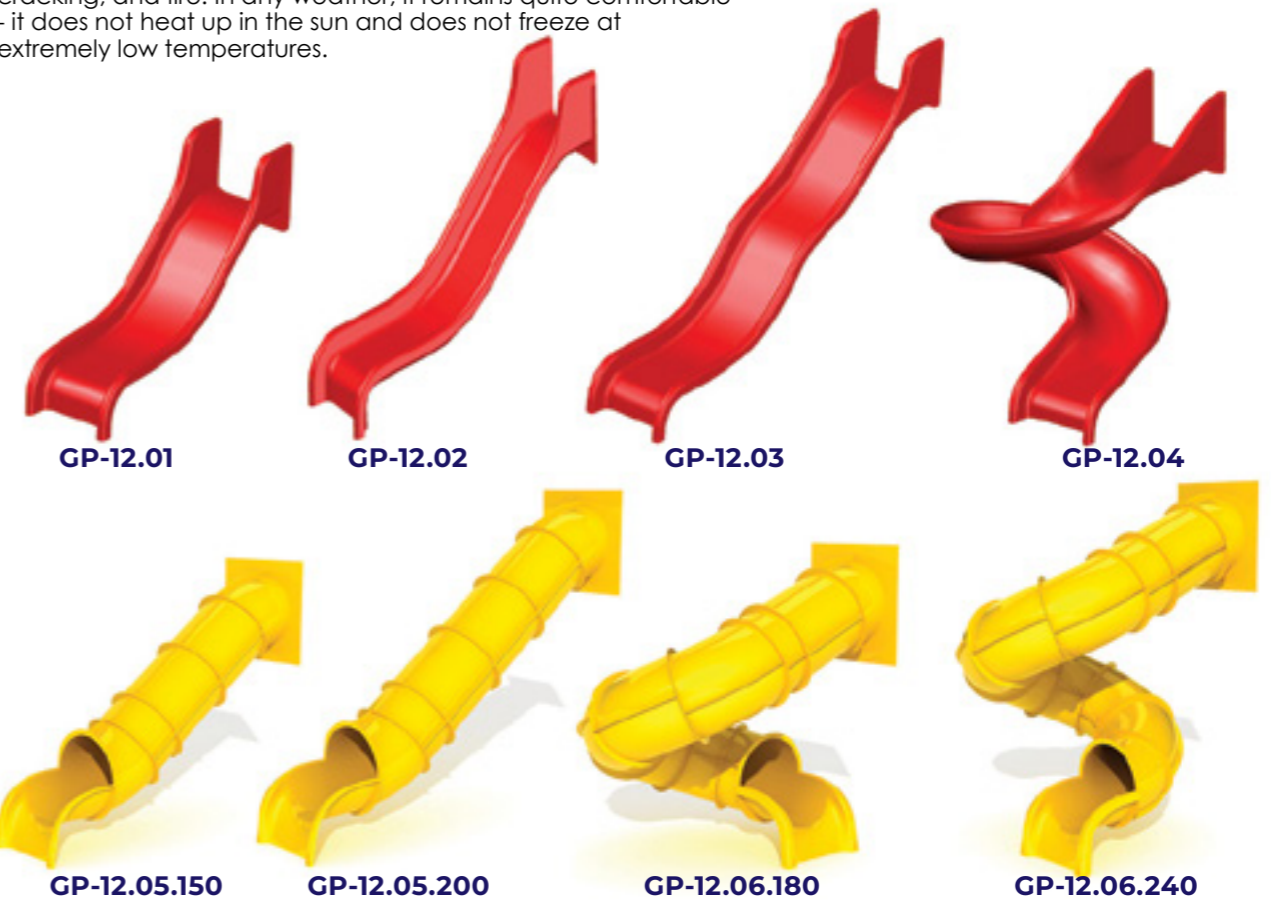

Model	Age	Accessibility	Information	Group size	Age range	Material	FG
GP-12.01	-	-	1,87x0,62	3-12	1	0,9	•
GP-12.02	-	-	2,27x0,62	3-12	1	1,2	•
GP-12.03	-	-	2,56x0,62	3-12	1	1,5	•
GP-12.04	-	-	1,6x1,6	3-12	1	1,5	•
GP-12.05.150	-	-	3,0x0,8	3-12	1	1,5	•
GP-12.05.200	-	-	3,55x0,8	3-12	1	2,0	•
GP-12.06.180	-	-	2,1x2,2x1,0	3-12	1	1,8	•
GP-12.06.240	-	-	2,1x2,3x1,0	3-12	1	2,4	•





## Батути/Trampolines

Дитячі батути – дуже гарні елементи на дитячому майданчику. Ці моделі батутів є компактними та універсальними конструкціями для ігор на свіжому повітрі. Конструкції безпечні, верхня платформа застелена гумовим покриттям.

Children's trampoline is a very nice element on the playground. These models of trampolines are compact and versatile designs for outdoor games. Trampoline structures are safe, the upper platform is covered with a rubber coating.

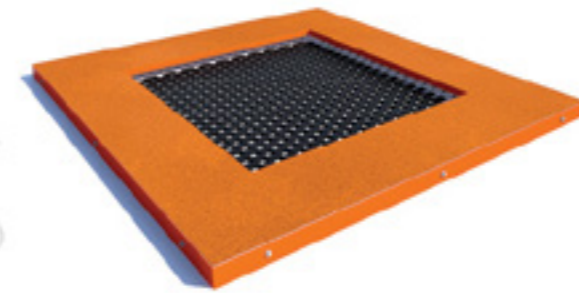

BT-1

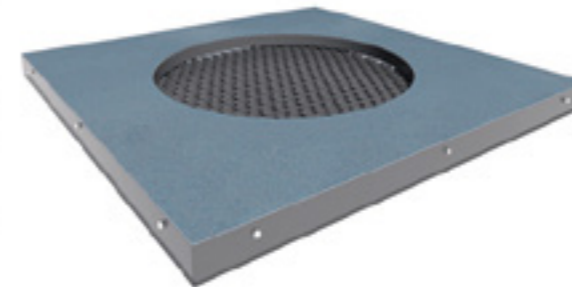

BT-2

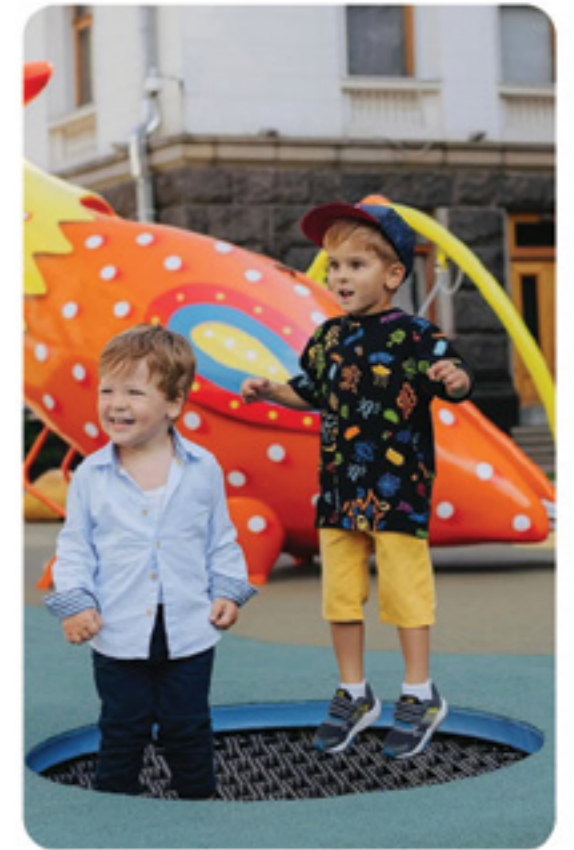

	A	♿	📏	📐	📐	👤	👤+	📊	🟩	🟩	RUBBER EPDM
BT-1	•	•	1,6x1,6x0,45 (полотно - 1x1) (canvas - 1x1)	12,25	0,9	3-14	2	120	•	-	•
BT-2	•	•	1,6x1,6x0,46 (D=1 m)	12,25	0,9	3-14	2	185	•	-	•

### ХАРАКТЕРИСТИКИ РОЗДІЛУ БАТУТИ / CHARACTERISTICS OF THE TRAMPOLINES SECTION

Деталі з оцинкованої сталі  
Galvanised steel construction

Деталі з нержавіючої сталі  
Stainless steel elements

Поверхня: кольорова гума  
Surface: coloured rubber

Міцні протиковзкі ПА ламелі  
Durable anti-slip PA lamellas

\* Варіанти матеріалів стосуються вибраних продуктів, для отримання додаткової інформації відвідайте [www.goida-da.com](http://www.goida-da.com)

\* Material options apply to selected products, for more information visit [www.goida-da.com](http://www.goida-da.com)









IK-4.10



IK-4.11

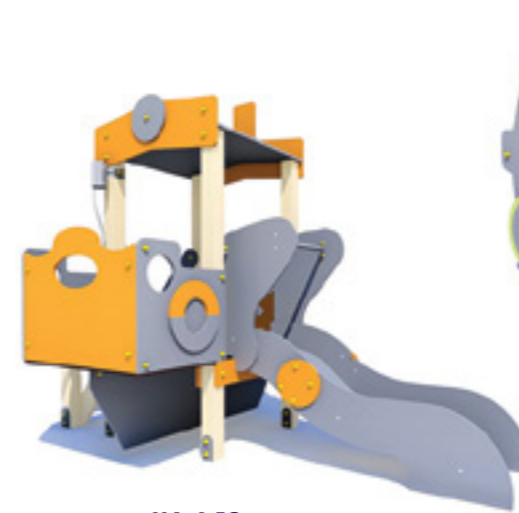

IK-4.12



IK-4.13

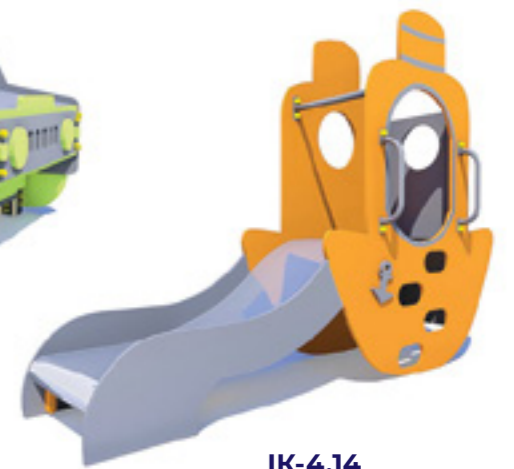

IK-4.14

	A	♿	📖	📐	📐	👤	👤+	📖	📐	📐	📐	HDPE	HPL
IK-4.10	-	•	•	•	•	•	•	•	•	•	•	•	•
IK-4.11	-	•	•	•	•	•	•	•	•	•	•	•	•

	A	♿	📖	📐	📐	👤	👤+	📖	📐	📐	📐	HDPE	HPL
IK-4.12	-	•	•	•	•	•	•	•	•	•	•	•	•
IK-4.13	-	•	•	•	•	•	•	•	•	•	•	•	•
IK-4.14	-	•	•	•	•	•	•	•	•	•	•	•	•





	A	♿	📏	📏	📏	👤	👤+	📏	📏	HDPE	
CD-4.01	-		0,9x0,4x3,0	21,5	1,6	1-6	1	21	●	●	-
CD-4.02	-		1,15x0,04x2,2	21	1,3	1-6	1	21	●	●	-
CD-4.05	-		0,8x0,8x2,4	23	-	1-6	3	24	●	-	-
CD-4.07	-		1,0x0,16x1,8	20	-	1-6	1	15	●	-	●
DS-3.19	-		1,8x1,8x2,7	-	-	1-6	-	117	●	●	-





## Квест-казка/Quest fairy tale

Чудова розвага для малюків – гра для дитячих майданчиків, парків, рослинних лабіринтів – квест-казка про допитливих зайчат. Прості умови дозволять брати участь дітям навіть наймолодшого віку. Гра вимагає багато рухатися, розвиває спритність, увагу, вчить спілкуванню та підтримці одне одного. Малюки весело та з захопленням проведуть час.

Great entertainment for kids – a game for playgrounds, parks, plant labyrinths – a quest-tale about curious hares. Simple conditions will allow even the youngest children to participate. The game requires a lot of movement, develops dexterity, attention, teaches communication and mutual support. Kids will have fun and enjoy their time.



### Казка про допитливих зайчат (завдання квесту)



Ранньою весною в заячій сім'ї народилося 15 зайчат. Спритні, непосидючі, і, особливо допитливі від народження малюки. Мама Зайчиха вибрала місце для свого будинку під колючим кущем, оскільки турбувалася про безпеку дітей. Зайченята дуже швидко дослідили свій будиночок і їм стало нудно. До того ж навкруги голосно лунав дитячий сміх. Потихеньку пустуни, обстежуючи околиці, стали розбідатися. Зайченята заховалися на ігровому майданчику і нишком спостерігають за веселощами дітлахів. Спробуй знайти всіх пустунів та дізнатися їхні імена – впиши їх до «Чарівної таблички».

### A tale of curious hares (quest task)

In early spring, 15 hares were born to a hare family. They were nimble, restless, and especially curious from birth. The mother hare chose a place for her house under a thorny bush because she was worried about the safety of the children. The bunnies quickly explored their house and got bored. In addition, children's laughter could be heard loudly around them. Slowly, the mischievous bunnies began to explore the neighborhood and started to wander off. The bunnies hid in the playground and watched the children's fun. Try to find all the pranksters and find out their names - write them in the «Magic Board».



CD-4.09







	A	♿	📖	👤	kg	■	🌀	HDPE
CD-4.06.01	●				2	●	●	○
CD-4.06.02	●				2	●	●	○
CD-4.06.03	●				2	●	●	○
CD-4.06.04	●				2	●	●	○



CD-4.06.05



CD-4.06.06



CD-4.06.07



CD-4.06.08



CD-4.06.09



CD-4.06.10



CD-4.06.11



CD-4.06.12



CD-4.06.13



CD-4.06.14



CD-4.06.15

	A	♿	📖	👤	kg	■	🌀	HDPE
CD-4.06.05	●				2	●	●	○
CD-4.06.06	●				2	●	●	○
CD-4.06.07	●				2	●	●	○
CD-4.06.08	●				2	●	●	○
CD-4.06.09	●				2	●	●	○
CD-4.06.10	●				2	●	●	○
CD-4.06.11	●				2	●	●	○
CD-4.06.12	●				2	●	●	○
CD-4.06.13	●				2	●	●	○
CD-4.06.14	●				2	●	●	○
CD-4.06.15	●				2	●	●	○





DS-3.02



DS-3.01



DS-3.03



DS-3.04



DS-3.05



DS-3.06



DS-3.07



DS-3.08

	A	♿	📖	📐	📐	👤	👤+	📊	📐	📐	HDPE
DS-3.01	-	2,51x0,18x0,3	33,5	< 0,60	1-6	2	45	●	●	-	
DS-3.02	-	3,0x0,8x0,6	33,6	< 0,60	1-6	2	28	●	-	-	
DS-3.03	-	1,0x0,4x2,0	7,2	< 0,60	1-6	1	45	●	●	-	
DS-3.04	-	1,33x0,05x1,85	21,5	1,9	1-6	1	30	●	-	-	
DS-3.05	-	2,85x2,12x1,94	41,9	< 0,60	1-6	2	175	●	●	○	
DS-3.06	-	1,5x0,2x0,5	23,1	< 0,60	1-6	1	33	●	●	○	
DS-3.07	-	1,0x0,4x1,5	7,2	< 0,60	1-6	2	40	●	●	○	
DS-3.08	-	0,3x0,3x0,3	2	< 0,60	1-6	1	5	●	●	○	



DS-3.09



DS-3.13



DS-3.15

	A	♿	📖	📐	📐	👤	👤+	📊	📐	📐	HDPE
DS-3.09	-	1,5x1,2x1,5	28,6	0,9	1-6	2	92	●	●	●	
DS-3.13	-	1,0x1,2x2,47	26,0	1,2	1-6	2	91	●	●	○	
DS-3.15	-	3,7x1,5x1,4	42,0	0,9	1-6	2	244	●	●	○	





IN - 12.15



IN - 12.16



IN - 12.04



KP-4.27

	A	♿	📖	📐	📏	👤	👥	📊	📏	📏	📏	HDPE	HPL
IN - 12.04	●					7-14	2	170	●	-	●	○	-
IN - 12.15	●					7-14	6	156	●	-	●	○	-
IN - 12.16	●					7-14	3	85	●	-	●	○	-
KP-4.27	●					3-6	2	46	●	○	●	●	-



DS-3.14



DS-3.17



DS-3.18



DS-3.20



DS-3.32



	A	♿	📖	📐	📏	👤	👥	📊	📏	📏	📏	HDPE
DS-3.14	-					1-6	4	41	●	-	●	○
DS-3.17	-					1-6	4	186	●	-	●	-
DS-3.18	-					1-6	2	170	●	-	●	○
DS-3.20	-					1-6	4	5	●	-	-	-
DS-3.32	-					1-6	1	22	●	●	-	●



## Ігрові панелі / Play panels

Ігрові панелі - це нове слово у світі вуличного дитячого устаткування. Ігрові панелі оснащені ротатійним механізмом і клавішами, які допомагають відтворювати звук музичного інструменту.

Play panels are a new word in the world of outdoor children's equipment. Game panels are equipped with a rotary mechanism and keys that help reproduce the sound of a musical instrument.



PP-14.07



PP-15.01

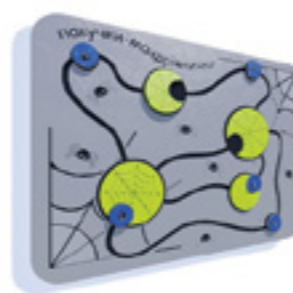

PP-15.04



PP-16.01

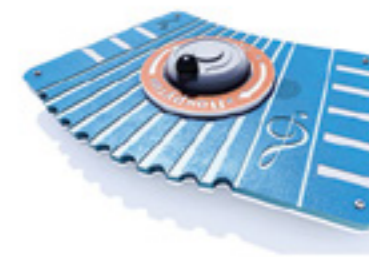

PP-16.02



PP-15.02



PP-15.03



PP-15.08



PP-15.04

0,8x0,6x0,05

3-12

1

9

•

o

•

PP-16.01

0,6x1,0x0,5

3-12

1

8

•

o

•

PP-16.02

0,72x0,53x0,15

3-12

1

10

•

o

•

	A	♿	📖	👤	👥	📖	📖	📖	HDPE
PP-14.07	•								•
PP-15-01	•								•
PP-15-02	•								•
PP-15-03	•								•
PP-15-08	•								•

	A	♿	📖	👤	👥	📖	📖	📖	HDPE
PP-15.04	•								•
PP-16.01	•								•
PP-16.02	•								•





PP-16.04



PP-16.03



PP-16.05



PP-16.06



PP-16.08



PP-16.09

	A	♿	🏠	👤	👤+	📦	🔍	HDPE
PP-16.03	●					12	●	●
PP-16.04	●					10	●	●
PP-16.05	●					12	●	●
PP-16.06	●					12	●	●
PP-16.08	●					9	●	●
PP-16.09	●					8	●	●



PP-16.07



PP-16.10

Музикальна панель додатково може комплектуватися стійкою з металу або нержавіючої сталі, також є можливість підключати до живлення з безпечною для людей напругою 6 V.

The music panel can additionally be equipped with a stand made of metal or stainless steel, it is also possible to connect it to a 6 V power supply that is safe for people.

	A	♿	🏠	👤	👤+	📦	🔍	HDPE
PP-16.07	●					10,0	●	●
PP-16.10	●					8,0	●	●
PPS-01	●					14,0	●	●

ХАРАКТЕРИСТИКИ РОЗДІЛІВ «ГРКИ» та «ТЕМАТИЧНІ ЕЛЕМЕНТИ» / FEATURES OF THE «SLIDES» and «THEMATIC ELEMENTS» SECTIONS

<ul style="list-style-type: none"> <li>Конструкція або елементи з нержавіючої сталі</li> <li>Stainless steel construction or elements</li> </ul>	<ul style="list-style-type: none"> <li>Конструкція або елементи з оцинкованої сталі</li> <li>Galvanised steel construction or elements</li> </ul>	<ul style="list-style-type: none"> <li>Дерев'яна конструкція</li> <li>Wood construction</li> </ul>	<ul style="list-style-type: none"> <li>Анкери оцинковані</li> <li>Galvanised anchors</li> </ul>	<ul style="list-style-type: none"> <li>PP тунелі</li> <li>PP tunnels</li> </ul>	<ul style="list-style-type: none"> <li>HDPE панелі</li> <li>HDPE panels</li> </ul>
<ul style="list-style-type: none"> <li>Гірки з нержавіючої сталі</li> <li>Stainless steel slides</li> </ul>	<ul style="list-style-type: none"> <li>Міцні роз'єми</li> <li>Durable connectors</li> </ul>	<ul style="list-style-type: none"> <li>Канати зі сталевим сердечником</li> <li>Ropes with steel core</li> </ul>	<ul style="list-style-type: none"> <li>Захисний верх</li> <li>Protective tops</li> </ul>		
<ul style="list-style-type: none"> <li>Конструкції:                             <ul style="list-style-type: none"> <li>● Пофарбована сталь</li> <li>● Нерж. сталь</li> </ul> </li> <li>Construction:                             <ul style="list-style-type: none"> <li>● Painted steel</li> <li>● Stainless steel</li> </ul> </li> </ul>	<ul style="list-style-type: none"> <li>Гірки:                             <ul style="list-style-type: none"> <li>- З нерж. сталі</li> <li>- Зі скловолокна</li> </ul> </li> <li>Slides:                             <ul style="list-style-type: none"> <li>- Stainless steel</li> <li>- Fiberglass</li> </ul> </li> </ul>	<ul style="list-style-type: none"> <li>Анкерування:                             <ul style="list-style-type: none"> <li>- Поверхня</li> <li>- Глибока</li> </ul> </li> <li>Anchoring:                             <ul style="list-style-type: none"> <li>- Surface</li> <li>- Deep</li> </ul> </li> </ul>			

\* Варіанти матеріалів стосуються вибраних продуктів, для отримання додаткової інформації відвідайте [www.goida-da.com](http://www.goida-da.com)

\* Material options apply to selected products, for more information visit [www.goida-da.com](http://www.goida-da.com)



## Комплекси для дітей від 3 до 6 років / Complexes for children from 3 to 6 years old

Ігровий комплекс - дуже популярний компонент дитячих майданчиків, складається з елементів для гри та розвитку найменших дітей.

Велика користь комплексів у тому, що малюки на них активно рухаються: стрибають, підіймаються сходами, скочуються з гірки, лазять по канату або скеледрому. У цей час у дитини зміцнюються м'язи та кістки, покращується координація, вивільняється енергія та прокидається апетит.

A playground complex is a very popular component of playgrounds, consisting of elements for the play and development of the youngest children.

The great benefit of the complexes is that kids move actively on them: jump, climb stairs, slide down a slide, climb a rope or a climbing wall. At this time, the child's muscles and bones strengthen, coordination improves, energy is released, and appetite awakens.



IK-5.04

IK-5.05



IK-5.08

IK-5.14



Model	Dimensions (LxWxH)	Weight (kg)	Height (m)	Age Range	Number of Children	Weight (kg)	Other	Material 1	Material 2	Material 3	Material 4	Material 5
IK-5.04	3,3x2,7x2,6	48,9	0,9	3-6	8	297	0,9	•	•	•	○	○
IK-5.05	5,8x3,3x2,4	71,5	0,9	3-6	12	660	0,6	•	•	•	○	○
IK-5.08	3,4x4,0x2,7	58,1	1,2	3-6	8	321	0,9	•	•	•	○	○
IK-5.14	6,4x6,7x3,2	110,2	2,5	3-6	12	666	0,9; 1,2	•	•	•	○	○







IK-5.17



IK-5.18



IK-5.20



IK-5.21

	A	♿	📖	🏠	📏	👤	👤+	📖	📏	📏	📏	📏	HDPE	HPL
IK-5.17	-	3,7x2,9x3,16	53,1	1,2	3-6	8	380	1,2	●	●	●	○	○	
IK-5.18	-	3,3x3,5x3,6	60,6	2,5	3-6	12	336	0,9	●	●	●	○	○	

	A	♿	📖	🏠	📏	👤	👤+	📖	📏	📏	📏	📏	HDPE	HPL
IK-5.20	-	3,8x4,4x3,3	64,7	1,2	3-6	8	443	1,2	●	●	●	○	○	
IK-5.21	-	6,0x4,2x3,2	75	2,5	3-6	14	590	1,2	●	●	●	○	○	





IK-5.23

												HDPE	HPL
IK-5.23	-	3,3x3,0x2,9	51,1	2	3-6	6	275	0,9	•	•	•	o	o



IK-5.22



IK-5.25

												HDPE	HPL
IK-5.22	-	3,8x4,3x3,2	64,7	1,2	3-6	14	460	1,2	•	•	•	o	o
IK-5.25	-	6,3x3,6x3,2	77,3	2,5	3-6	8	447	1,2	•	•	•	o	o





IN - 12.01



IN - 12.01.1



IN - 12.01	●	8,1x7,0x2,5	133	1,6	7-14	10	1128	-	●	-	●	○	○
IN - 12.01.1	●	10,7x6,6x3,2	139	1,6	7-14	10	1570	0,9	●	●	●	○	○











IK-6.09



IK-6.15



IK-6.08

IK-6.08	-	6,8x6,2x3,6	110	2,6	7-12	16	1025	1,5	•	•	•	o	o

IK-6.09	-	4,5x5,6x3,4	82	1,5	7-12	16	754	1,5	•	•	•	o	o
IK-6.15	-	3,8x4,8x3,4	69	2,7	7-12	12	449	1,5	•	•	•	o	o





IK-6.21

IK-6.23



IK-6.37

	A	♿	📐	📐	📐	👤	👤+	📊	📏	●	●	●	○	○
IK-6.21	-		5,0x2,9x3,4	59	1,8	7-12	8	470	1,5	●	●	●	○	○
IK-6.23	-		3,7x3,5x3,2	59,2	2,7	7-12	6	350	1,2	●	●	●	○	○

	A	♿	📐	📐	📐	👤	👤+	📊	📏	●	●	●	○	○
IK-6.37	-		6,3x7,1x3,8	114,3	2,7	7-12	18	885	1,5	●	●	●	○	○





IK-6.28



IK-6.29



IK-6.28	-	5,2x6,6x3,5	96,4	2,7	7-12	18	852	1,2; 1,5	•	•	•	○	○
IK-6.29	-	6,1x6,0x3,47	101	2,7	7-12	18	743	1,5	•	•	•	○	○





IK-6.46



IK-6.50

												HDPE	HPL
IK-6.46	-	7,9x10,0x4,4	166,6	2,7	7-12	26	1090	1,5	•	•	•	o	o

												HDPE	HPL
IK-6.50	-	9,0x6,8x5,9	140	2,7	7-12	36	1260	1,5	•	•	•	o	o





IK-6.53

												HDPE	HPL
IK-6.53	-	11,5x10,7x4,2	227,8	2,7	7-12	54	2258	1,2; 1,5	•	•	•	o	o



IK-6.59

												HDPE	HPL
IK-6.59	-	6,6x7,4x3,7	129,6	2,7	7-12	54	1328	1,2	•	•	•	o	o



**Комплекси «ПЛАСТ» для дітей від 7 до 14 років /  
«PLAST» complexes for children from 7 to 14 years old**



IK-6.75



												HDPE	HPL
IK-6.75	-	6,4x3,0x5,4	87	2,7	7-14	24	964	1,5	•	•	•	o	o



IK-6.74

												HDPE	HPL
IK-6.74	-	5,6x2,8x4,9	64,3	2,7	7-14	24	782	1,5	•	•	•	o	o





IK-6.76

												HDPE	HPL
IK-6.76	-	7,6x5,1x3,4	105	2,7	7-14	30	1114	1,5	•	•	•	o	o



IK-6.79

												HDPE	HPL
IK-6.79	-	5,2x4,0x3,4	73,6	1,5	7-14	18	652	1,5	•	•	•	o	o





Hit!

IK-6.80

IK-6.80	-	8,26x5,98x5,5	122,3	2,6	7-14	36	1450	1,5	•	•	•	o	o





**Комплекси «МЕГА» для дітей від 7 до 14 років / «MEGA» complexes for children from 7 to 14 years old**



IK-7.07



IK-7.07 - 13,7x13,2x5,07 304 2,6 7-14 36 3198 2,0; 1,7 • • • •

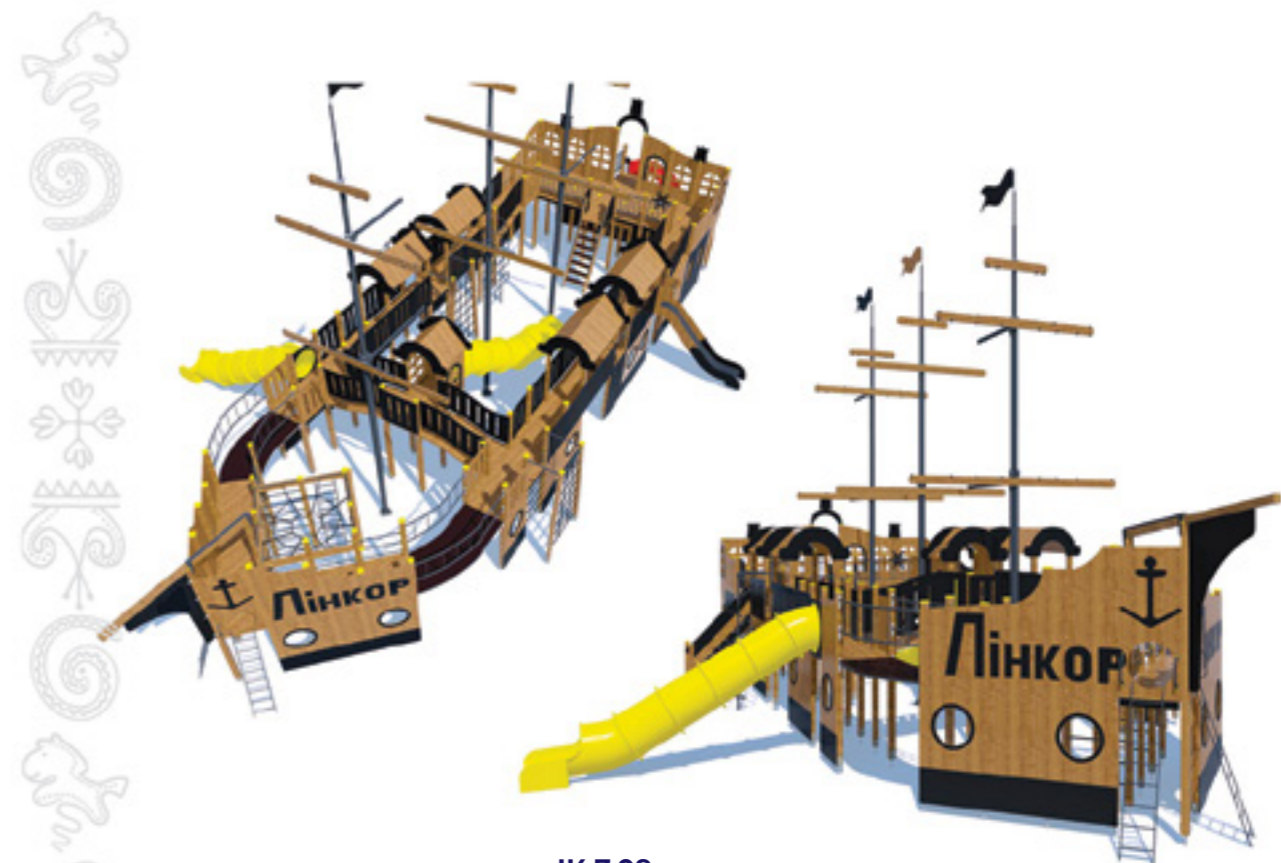

IK-7.09



IK-7.09 - 23,2x13,8x5,5 484,2 2,6 7-14 48 7139 1,7; 2,0 • • • •



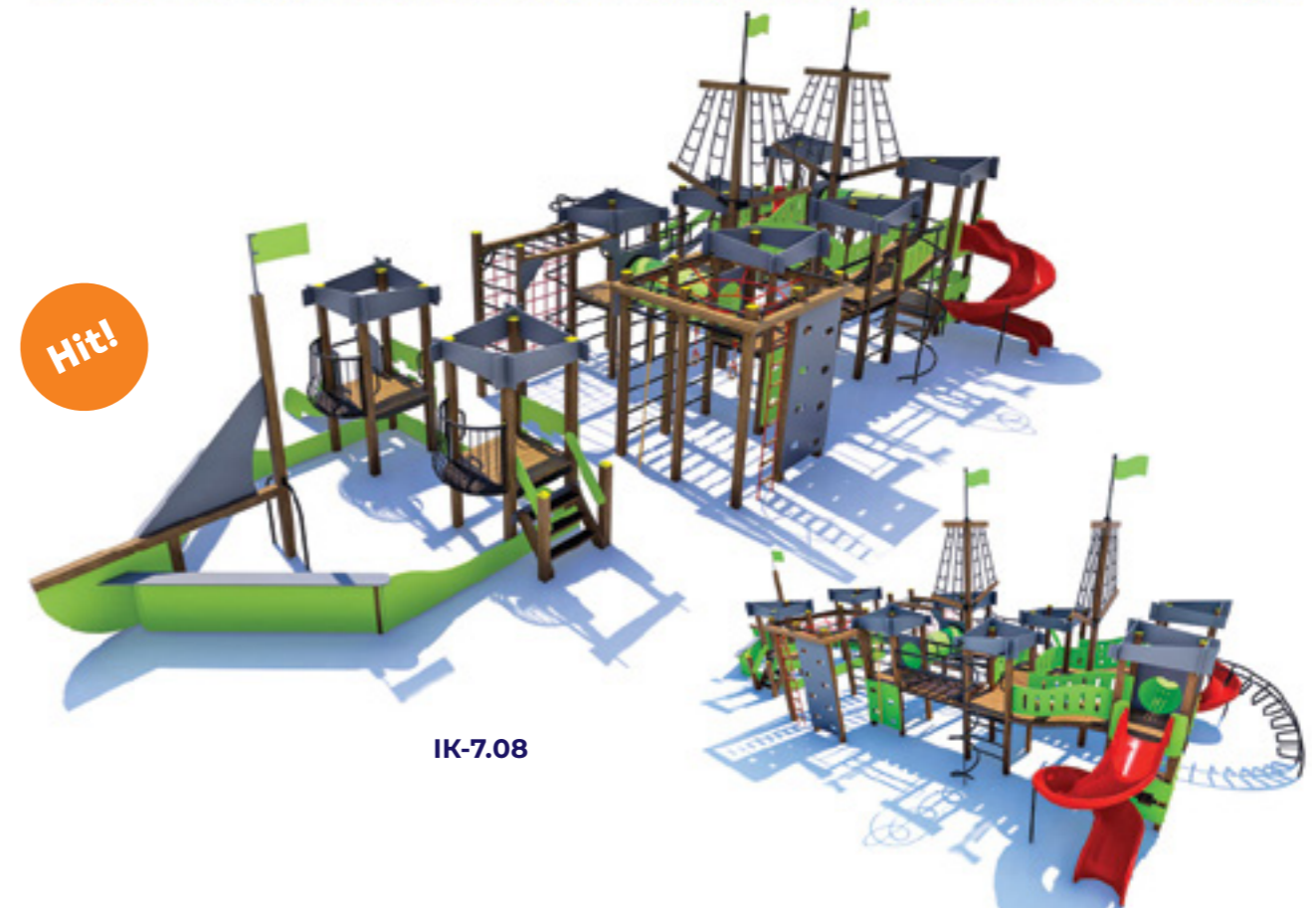

IK-7.08

IK-7.08	-	16,8x7,1x5,5	230,8	2,6	7-14	48	2674	0,6; 1,5	•	•	•	o	o



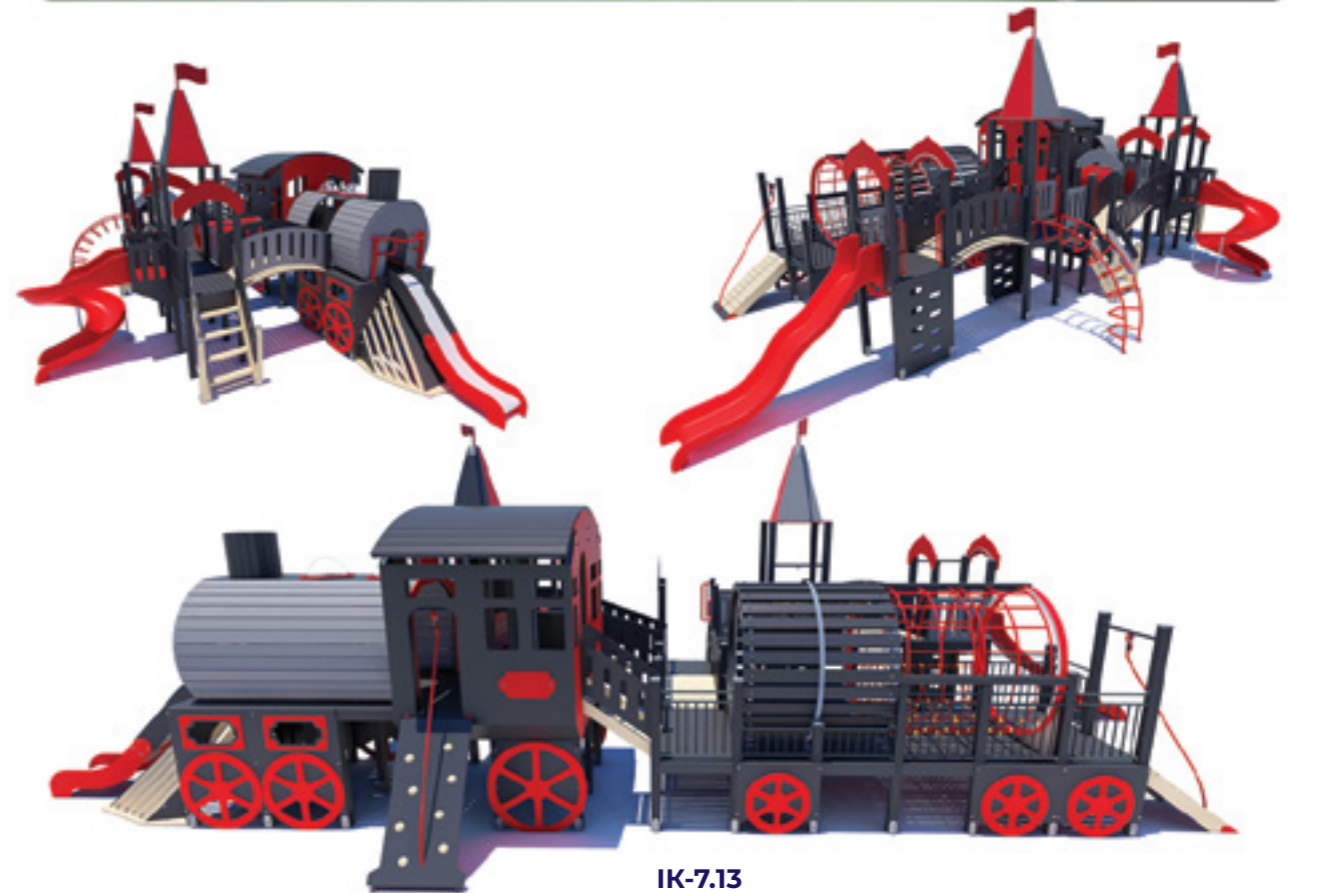

IK-7.13	-	15,89x8,11x5,15	240,9	1,7	7-14	40	3923	1,5	•	•	•	a	a







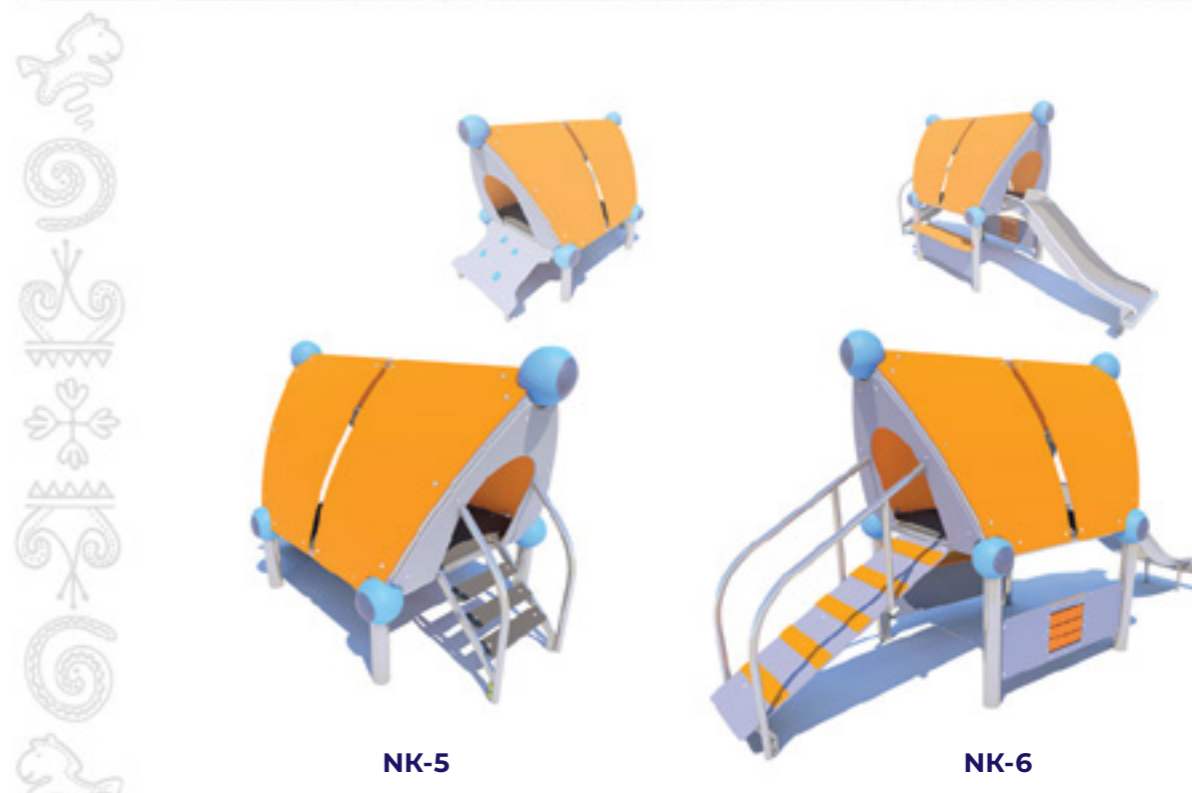
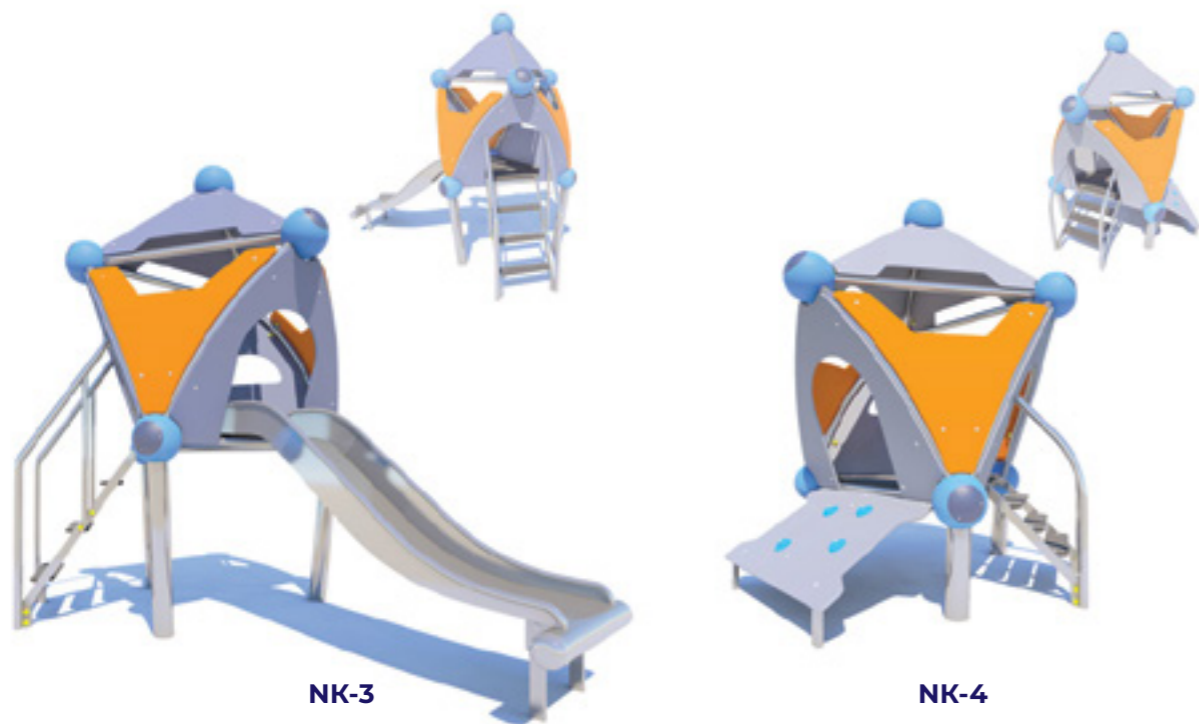
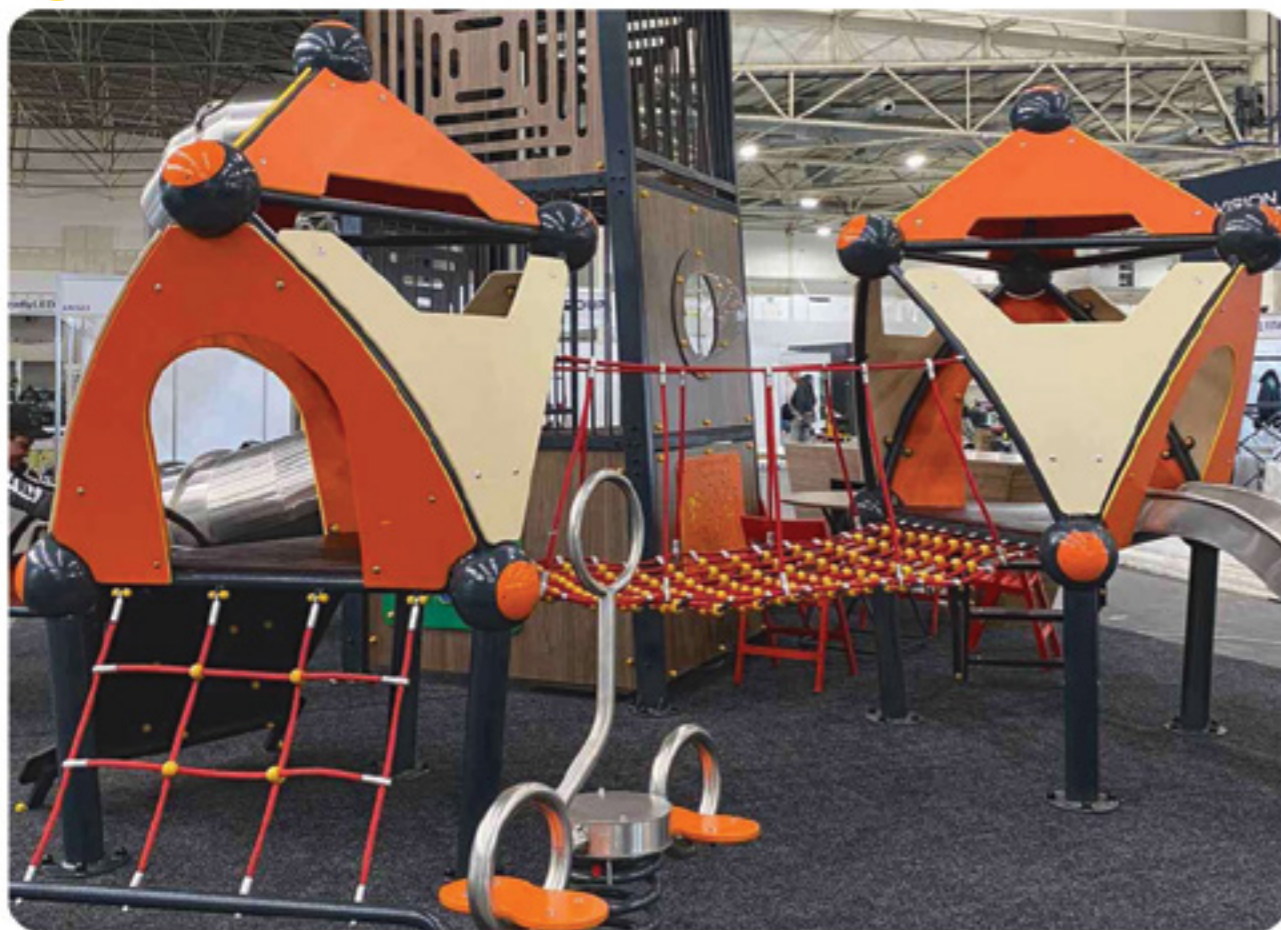

	A	♿	📖	📐	📐	👤	👤+	📖	📐	📐	📐	HDPE	HPL
NK-3	-			44	0,9	7-14	6	273	0,9	●	●	●	○
NK-4	-			35	0,45	3-14	6	232	-	●	-	●	○

	A	♿	📖	📐	📐	👤	👤+	📖	📐	📐	📐	HDPE	HPL
NK-5	-			35	0,45	3-14	8	240	-	●	-	●	○
NK-6	-			47	0,9	7-14	8	322	0,9	●	●	●	○





NK-7



NK-8



	A	♿	📖	📐	📐	👤	👤+	📊	📏	📏	📏	HDPE	HPL
NK-7	-	4,4x1,6x2,06	47	0,9	7-14	8	285	0,9	●	●	●	●	○
NK-8	-	6,2x5,75x2,6	98	0,9	7-14	18	686	0,9	●	●	●	●	○



NK-9

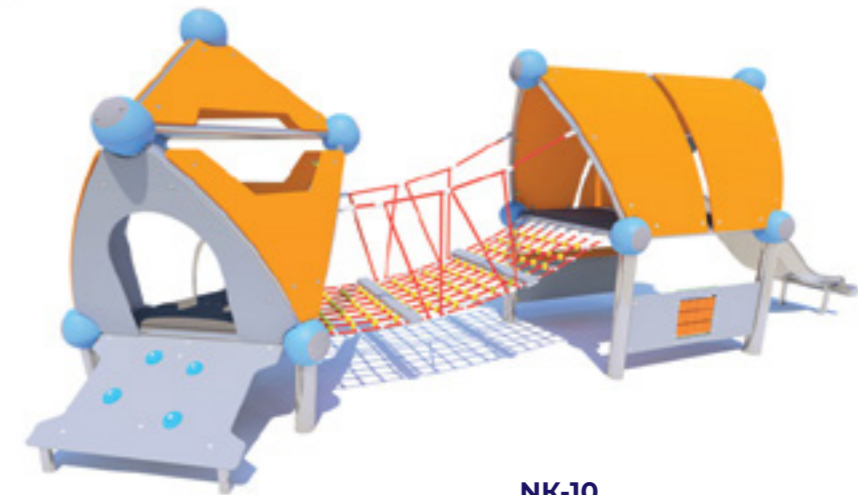

NK-10

	A	♿	📖	📐	📐	👤	👤+	📊	📏	📏	📏	HDPE	HPL
NK-9	-	4,0x1,9x2,6	47	0,9	7-14	12	395	0,9	●	●	●	●	○
NK-10	-	3,58x1,6x2,06	43	0,9	7-14	12	272	0,9	●	●	●	●	○



## Гімнастичні комплекси для дітей від 7 до 14 років / Gymnastic complexes for children from 7 to 14 years old

Рухливі ігри мають позитивний вплив та добре позначаються на здоров'ї. Тренування м'язів, розвиток витривалості, поліпшення спритності складають основу правильних занять та гарантують хороше самопочуття. Спортивні комплекси з кільцями, турніками, шведськими стінками, канатними рукоходами та сходами стануть центром уваги та відмінним місцем для розвивальних тренувань дітей і дорослих на свіжому повітрі.

Outdoor games have a positive effect and are good for health. Muscle training, development of endurance, improvement of dexterity are the basis of proper training and guarantee good health. Sports complexes with rings, horizontal bars, Swedish walls, rope climbing walls and ladders will become the center of attention and a great place for developmental training for children and adults in the fresh air.



GK-8.01

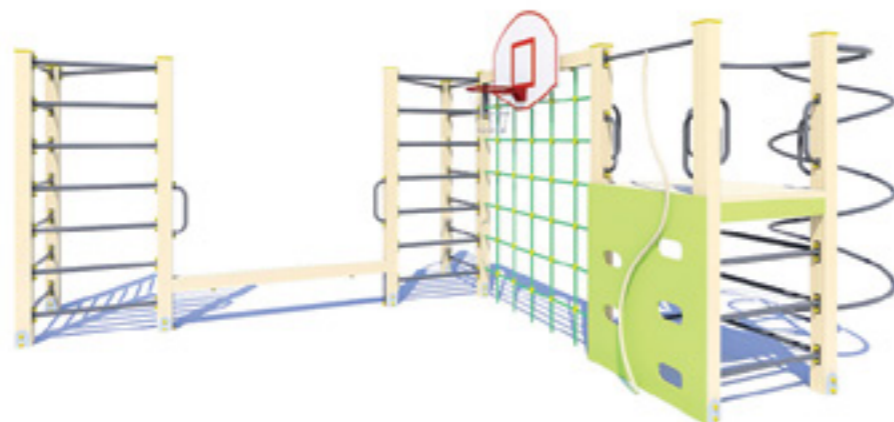

GK-8.02



GK-8.03



Model	Dimensions	Weight	Height	Age Range	Users	Weight Limit	Material 1	Material 2	Material 3	Material 4	Material 5
GK-8.01	2,1x1,1x2,5	31,1	2,5	7-14	6	134	●	○	●	○	○
GK-8.02	5,3x4,0x2,8	74,4	2,8	7-14	10	274	●	○	●	○	○
GK-8.03	2,1x2,1x2,6	37,2	2,5	7-14	8	272	●	○	●	○	○







GK-8.04

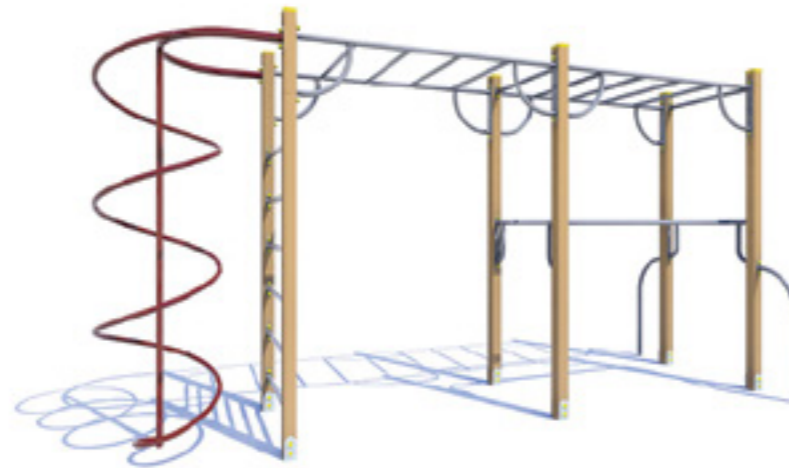

GK-8.06

	A	♿	📏	📐	📐	👤	👤+	📊	⬛	⬜	🌳	HDPE	HPL
GK-8.04	-	3,5x4,0x2,8	60	2,8	7-14	8	274	●	○	●	○	○	○
GK-8.06	-	4,8x1,65x2,6	50	2,5	7-14	6	203	●	○	●	○	○	○



GK-8.08



GK-8.12

	A	♿	📏	📐	📐	👤	👤+	📊	⬛	⬜	🌳	HDPE	HPL
GK-8.08	-	4,3x1,5x2,7	45,6	2,7	7-14	8	342	●	○	●	○	○	○
GK-8.12	-	9,95x7,9x2,37	165,4	1,2	7-14	36	1367	●	○	●	○	○	○





GK-8.14



GK-8.21

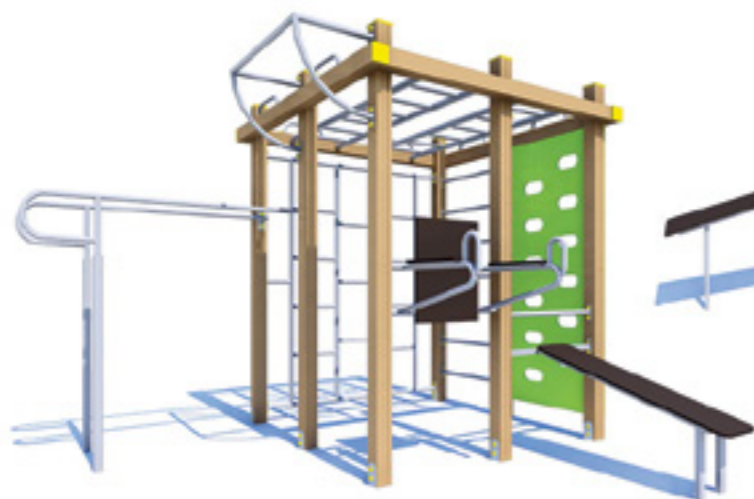

GK-8.20



	A	♿	📐	📐	📐	👤	👤+	📊	🔲	🔲	🌳	HDPE	HPL
GK-8.14	-		2,4x2,4x2,5	70,5	2,5	7-14	10	289	●	○	●	○	○
GK-8.20	-		3,2x3,55x2,6	54,3	2,6	7-14	10	288	●	○	●	○	○
GK-8.21	-		5,29x3,01x2,9	59,2	2,9	7-14	8	369	●	○	●	○	○



GK-8.22



GK-8.26

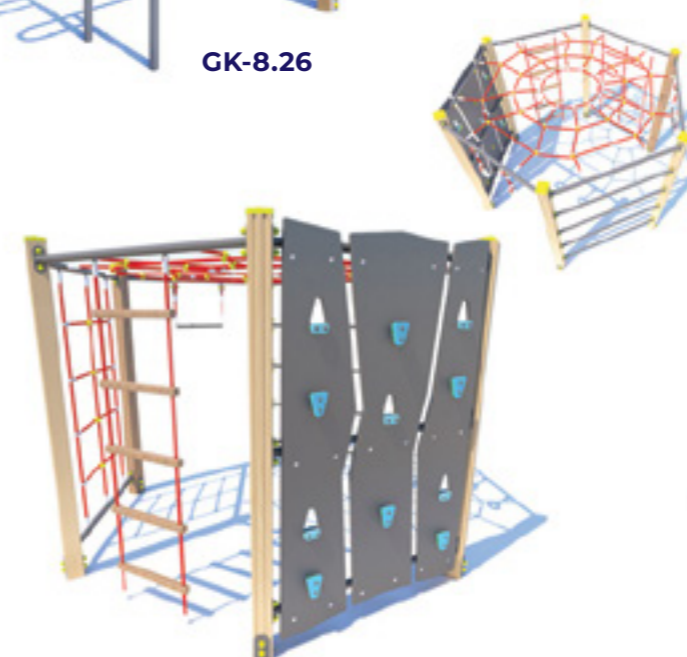

GK-8.29



SO-9.23

	A	♿	📐	📐	📐	👤	👤+	📊	🔲	🔲	🌳	HDPE	HPL
GK-8.22	-		4,65x4,08x3,65	69,8	1,2	7-14	10	-	●	○	●	○	○
GK-8.26	-		2,58x2,07x2,5	39,9	2	7-14	4	137	●	○	●	○	○
GK-8.29	-		2,9x2,55x2,07	45	2	7-14	12	179	●	○	●	○	○
SO-9.23	-		3,6x2,9x2,5	51,7	2,5	7-14	8	215	●	○	●	○	○



**КОМПЛЕКСИ-НОВИНКИ** для дітей від 7 до 14 років /  
**NEW COMPLEXES** for children from 7 to 14 years old



IKL-5.01



IKL-5-01/HPL - 6,64x4,93x3,86 95 1,5 6-14 16 794 1,5 • • • •





IKL-5.02



IKL-5.03

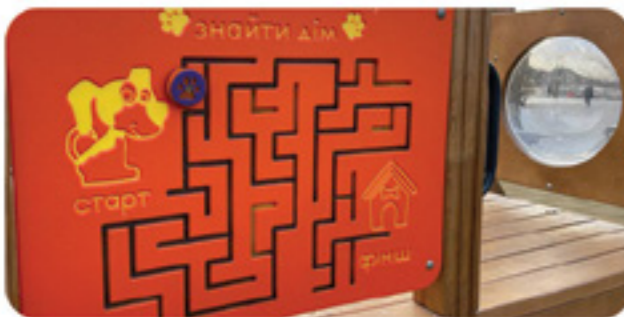

IKL-5.02/HPL	-	6,4x7,0x2,05	114,4	2,05	3-12	16	815	0,9	•	•	•	•

IKL-5.03	-	9,85x5,85x3,36	136	2,7	6-14	24	1180	0,9; 1,5	•	•	•	•





IKL-5-05	-	10,3x3,9x4,0	113	2,6	6-14	36	915	0,9; 1,5	•	•	•	a	a





IKW-14.04



IKW-14.08



Model	Code	Dimensions (LxWxD)	Area (m²)	Height (m)	Age Range	Capacity	Weight (kg)	Material 1	Material 2	Material 3	Material 4	Material 5	Material 6	Material 7
IKW-14.04	-	4,1x1,97x3,06	54,8	1,2	6-14	6	273	1,2	•	•	•	•	•	•
IKW-14.08	-	6,6x3,5x2,02	78,9	1,2	6-14	12	351	-	•	•	•	•	•	•

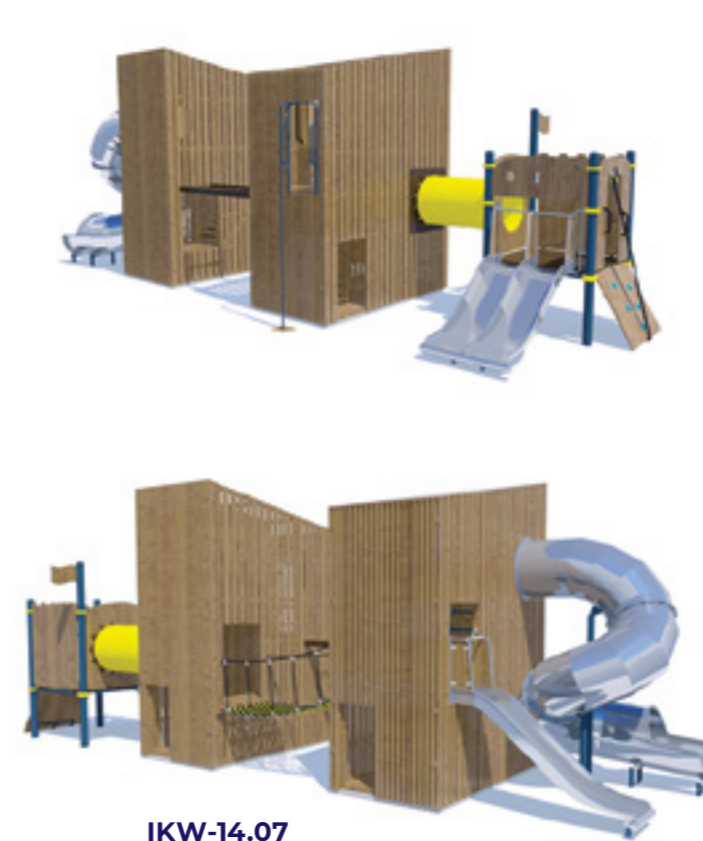

IKW-14.07



Model	Code	Dimensions (LxWxD)	Area (m²)	Height (m)	Age Range	Capacity	Weight (kg)	Material 1	Material 2	Material 3	Material 4	Material 5	Material 6	Material 7
IKW-14.07	-	11,23x3,37x3,99	112,2	3,3	6-14	25	2912	0,9; 1,2; 2,4	•	•	•	•	•	•





IKW-14.09

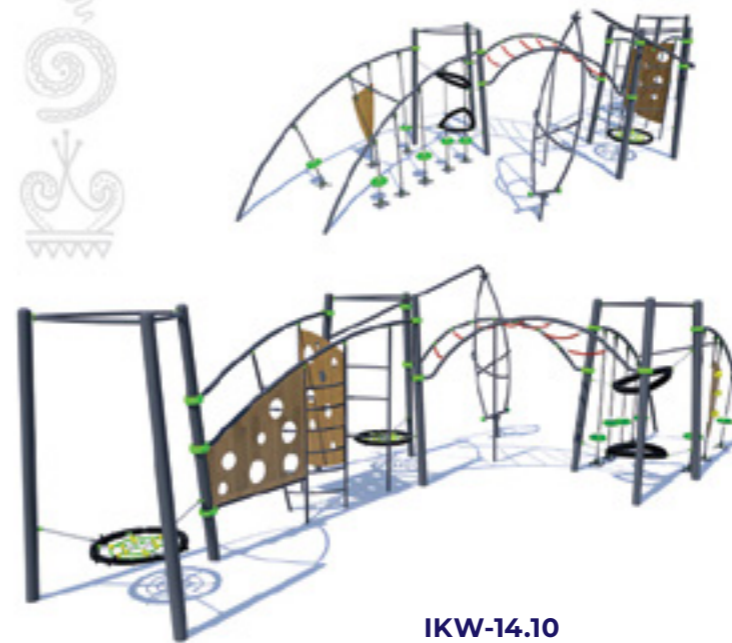

IKW-14.10



IKW-14.11



IKW-14.09	-	4,78x4,57x2,66	73,3	0,6	3-12	24	582	0,6	•	•	•	•	•	•
HDPE plastic														



IKW-14.10	-	10,2x5,56x2,87	135,7	2,5	6-14	12	766	-	•	•	•	•	•	•
IKW-14.11	-	3,8x5,74x6,29	75,9	1,2	6-14	16	1963	3,5	•	•	•	•	•	•
HDPE plastic														









Hit!



IKW-14.13	-	4,28x2,37x5,5	52,7	1,2	6-14	16	960	2,4	•	•	•	•



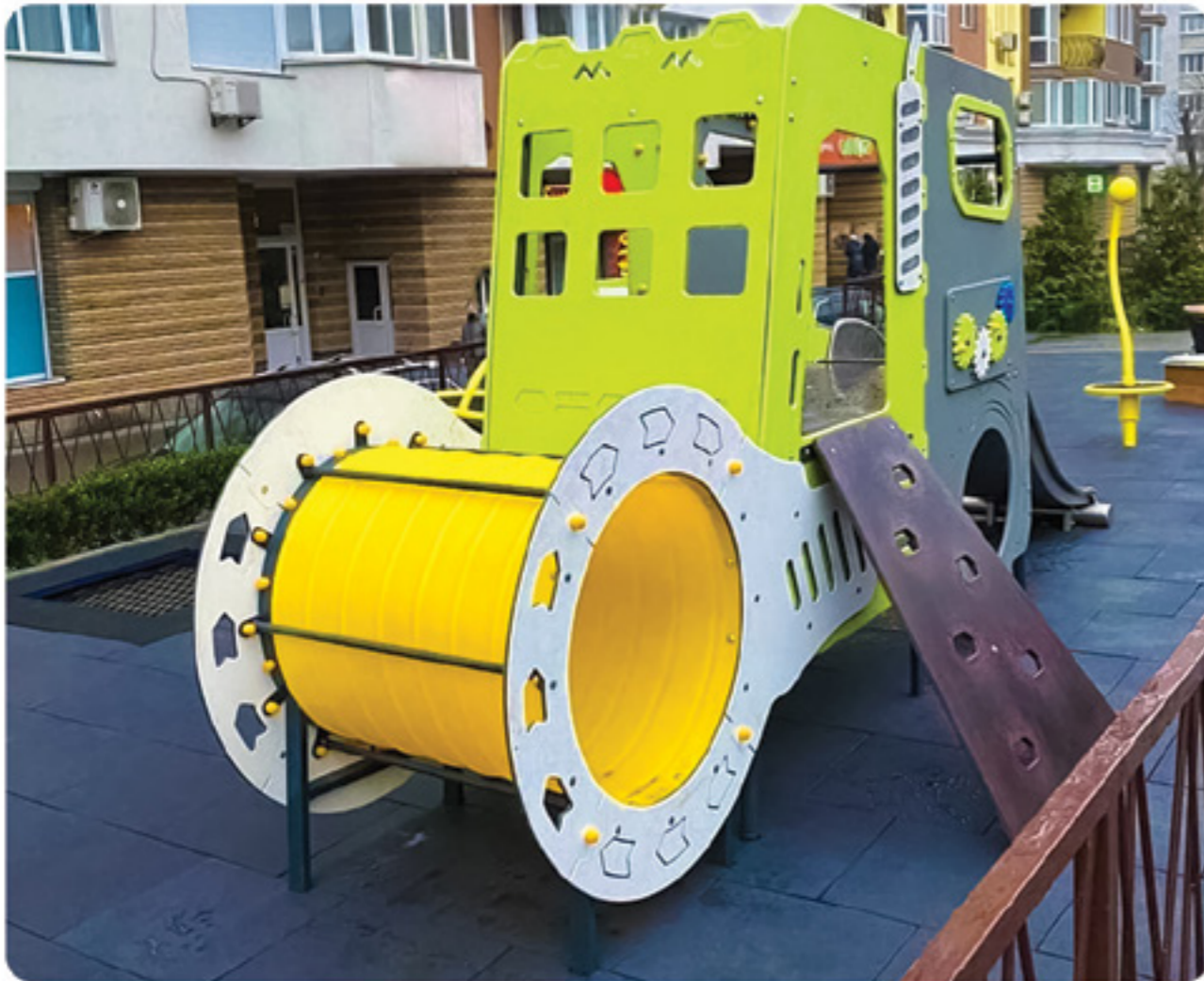

IKW-14.12



													HDPE	HPL
IKW-14.12	-	4,79x2,36x2,01	55,9	0,9	3-12	10	342	0,9	•	•	•	•	•	•



IKW-14.15



IKW-14.17

													HDPE	HPL
IKW-14.15	-	5,52x3,1x1,47	67,5	<0,6	3-12	12	514	-	•	•	•	•	•	•
IKW-14.17	-	5,95x5,38x4,92	93,3	1,2	6-14	20	1568	1,5	•	•	•	•	•	•





IKW-14.16



IKW-14.16	-	5,3x4,4x7,3	78,7	1,2	6-14	16	2840	3,5	•	•	•	o	o

Характеристики розділу ІГРОВІ КОМПЛЕКСИ/ Characteristics of the GAME COMPLEXES section

- Деталі з оцинкованої сталі  
Galvanised steel construction
- Деталі з нержавіючої сталі  
Stainless steel construction or elements
- У конструкції є рухомі елементи  
The design has moving elements
- HDPE панелі  
HDPE panels
- Панелі з полікарбонату (PC)  
Polycarbonate (PC) panels
- Анкерування поверхнєве та глибоке  
Anchoring is superficial and deep
- Гірки з нержавіючої сталі  
Stainless steel slides
- У складі виробу є елементи з дерева  
The product contains elements made of wood
- Мотузки зі сталевим сердечником  
Ropes with steel core
- Захисні верхи  
Protective tops
- Використовуються оцинковані анкери  
Galvanized anchors are used
- У комплекті моделі PP-тунелі  
The model of the PP-tunnel is included
- Конструкція обладнана гірками-трубами з нержавіючої сталі  
The construction is equipped with stainless steel pipe slides

Кольори та матеріали\*/Colors and materials\*:

- Конструкція:  
• Пофарбована сталь RAL1011  
• Дерево  
Construction:  
• Painted steel RAL1011  
• Stainless steel
- Гірки:  
- Нержавіюча сталь  
- Скловолокно  
Slides:  
- Stainless steel  
- Fiberglass
- Труби:  
- Нержавіюча сталь  
- PE  
Tubes:  
- Stainless steel  
- PE

\* Варіанти матеріалів стосуються вибраних продуктів, для отримання додаткової інформації відвідайте [www.goida-da.com](http://www.goida-da.com)  
\* Material options apply to selected products, for more information visit [www.goida-da.com](http://www.goida-da.com)



# Канатні комплекси / Rope complexes

Не схожі на звичайні майданчики, різні канатні комплекси не тільки привертають увагу дітей, але й будуть доповняти будь-яку місцевість. Різноманітні конфігурації канатних комплексів призначені для дітей різного віку. Для маленьких це невеликі, нескладні та безпечні лазалки, а для діток які старше – сітки зі складним футуристичним дизайном, які не тільки привабливі зовні, але й займаючись на них можна розвивати спритність, витривалість та фізичну силу.

Unlike ordinary playgrounds, various rope complexes not only attract the attention of children, but will also complement any area. Various configurations of rope complexes are designed for children of different ages. For little ones, these are small, simple and safe climbing walls, and for older children, nets with a complex futuristic design, which are not only attractive in appearance, but also help to develop agility, endurance and physical strength

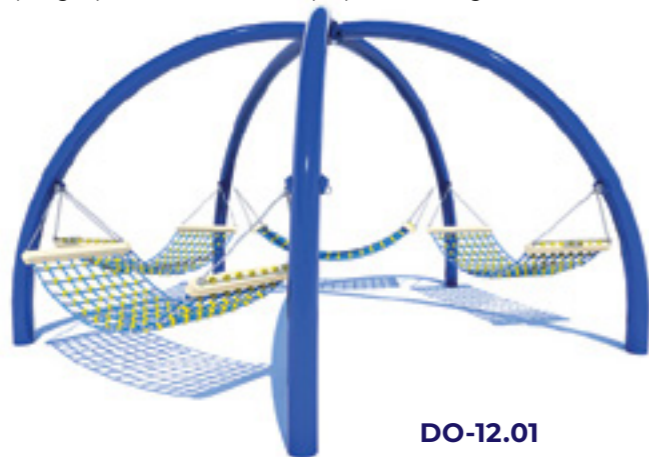

DO-12.01

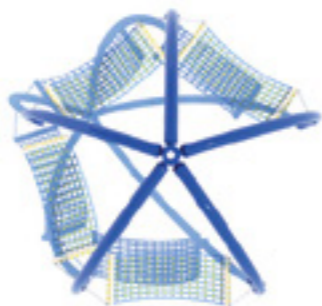

DO-12.01 - 5,5x5,5x3,3 86,4 2,5 7-14 2,5 313 ● ○ - - -

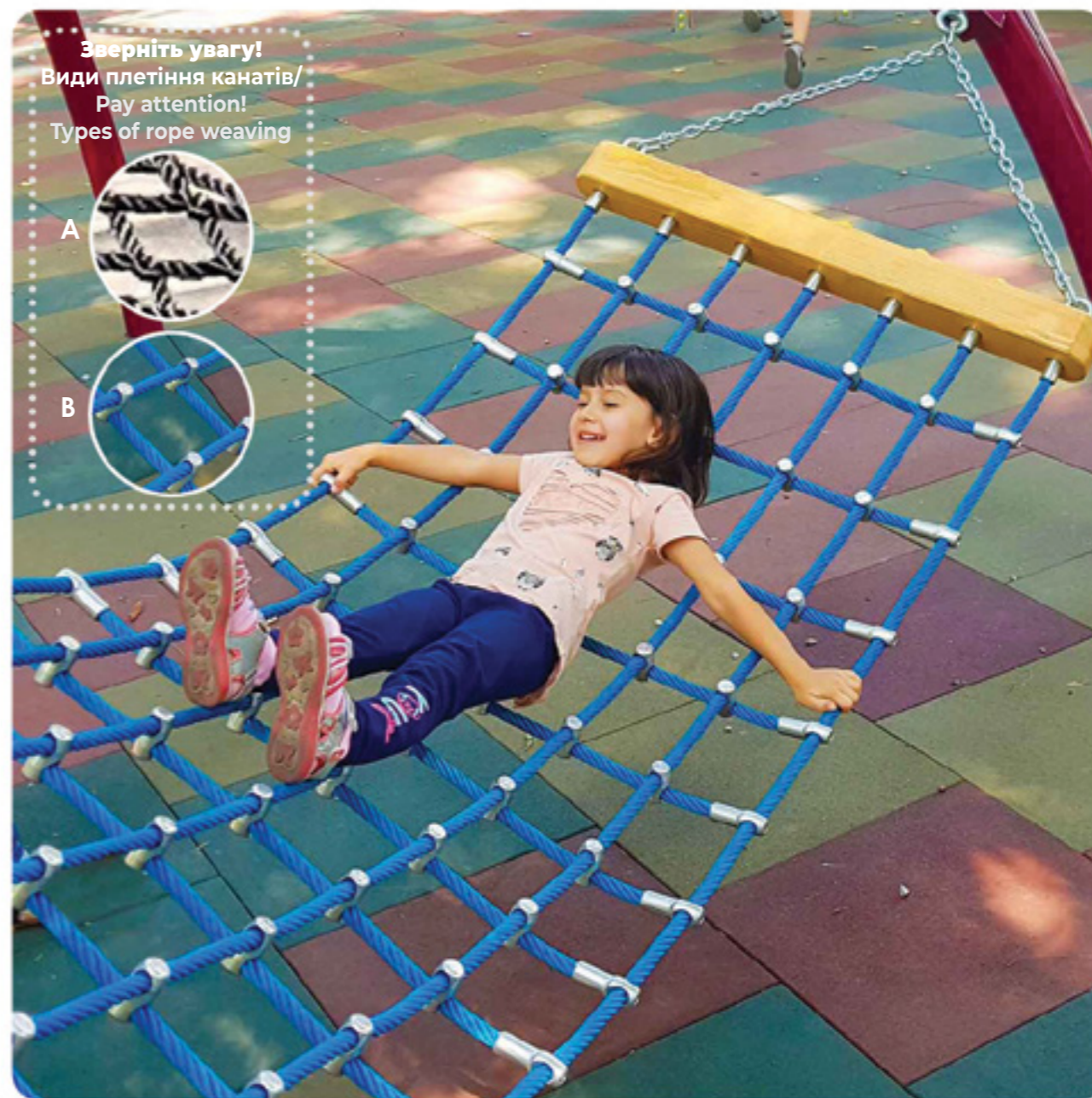

**Зверніть увагу!**  
Види плетіння канатів/  
Pay attention!  
Types of rope weaving

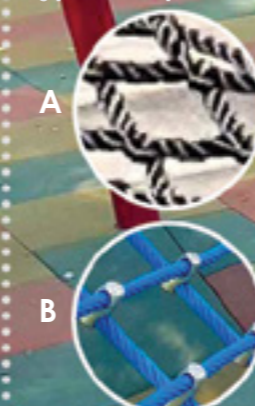



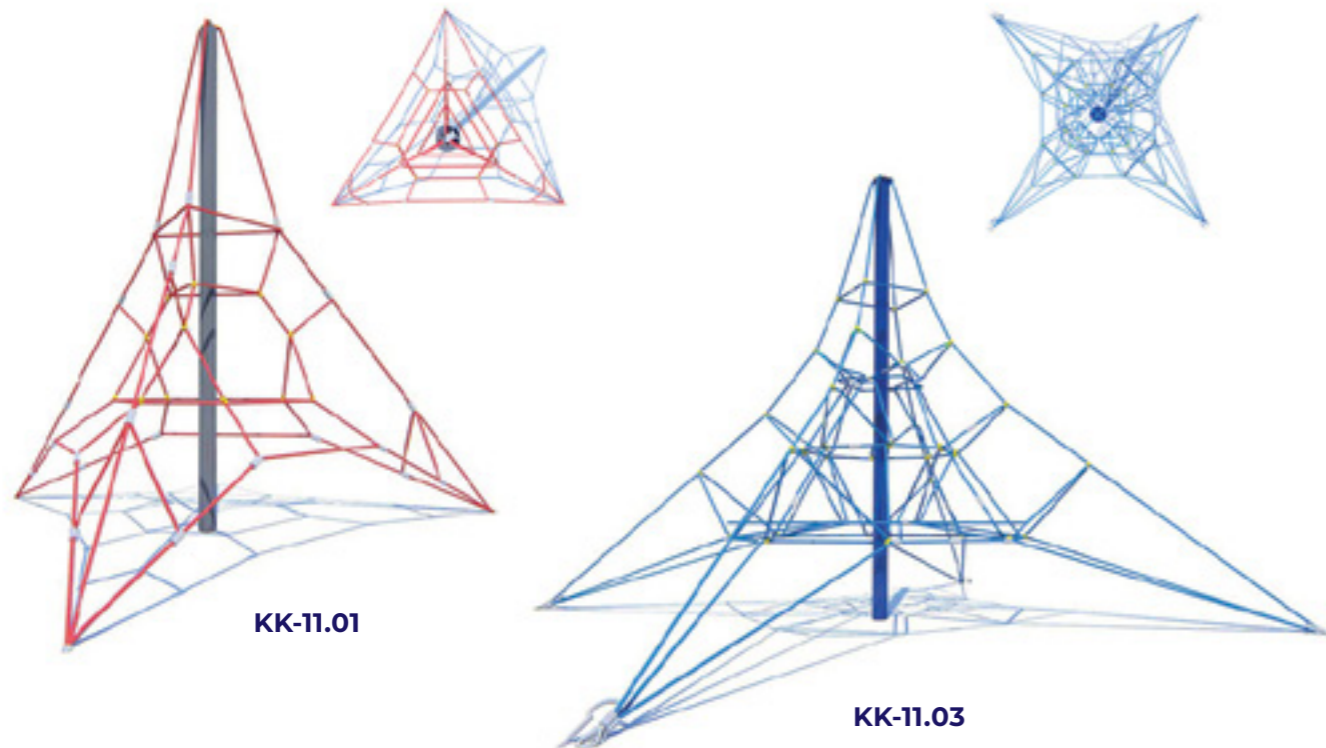

	A	♿	📏	📏	📏	👤	👤+	📏	⬤	⬦	📏	HDPE	HPL
KK-11.01	-		3,75x4,3x3,0	64,3	1,8	7-14	10	188	●	○	-	-	-
KK-11.03	-		7,0x7,0x3,4	116,6	2,2	7-14	14	249	●	○	-	-	-

	A	♿	📏	📏	📏	👤	👤+	📏	⬤	⬦	📏	HDPE	HPL
KK-11.17	-		2,39x2,39x2,3	40,8	< 0,60	7-14	8	248	●	○	-	-	-
KK-11.18	-		3,4x1,6x1,2	41,4	< 0,60	7-14	4	-	●	○	-	-	-



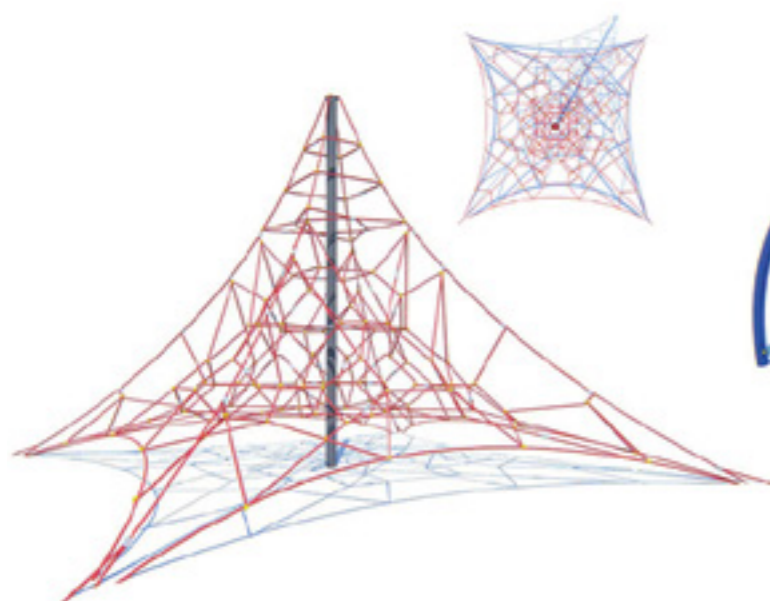

KK-11.05

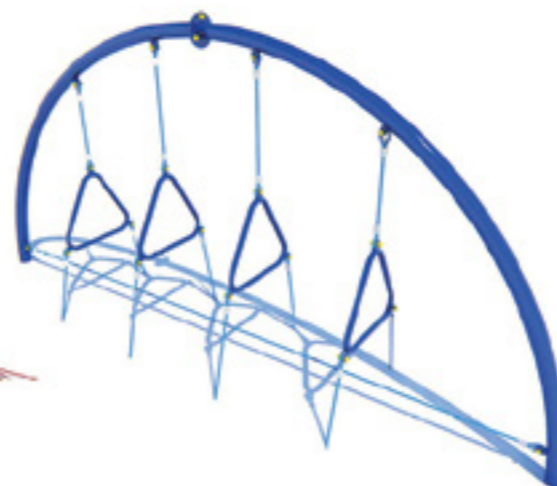

KK-11.19

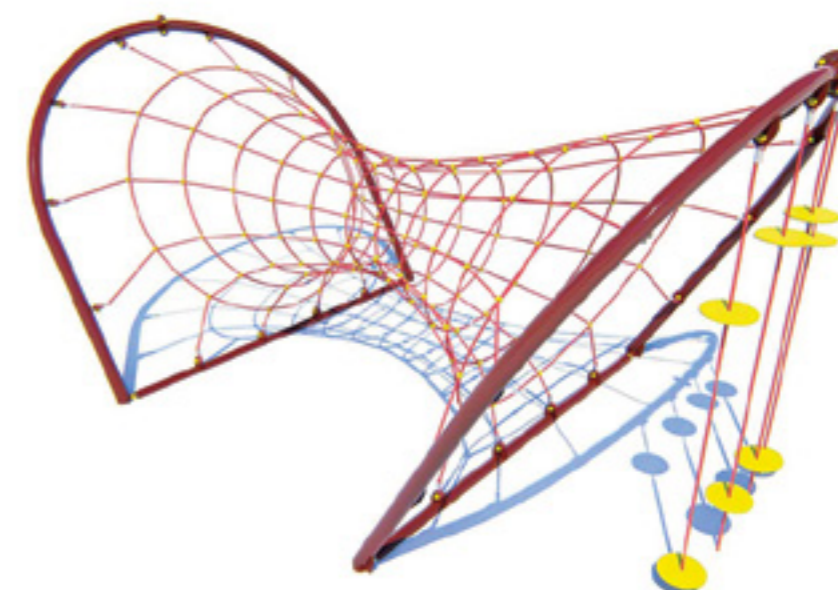

KK-11.20

Model	Code	Dimensions (LxWxH)	Area (m²)	Height (m)	Age Range	Capacity	Weight (kg)	Material	Finish	Coating	Material	Material
KK-11.05	-	8,0x8,0x4,4	144	3,2	7-14	32	266	•	α	-	-	-
KK-11.19	-	5,34x1,25x2,73	49,5	1	7-14	8	200	•	α	-	-	-

Model	Code	Dimensions (LxWxH)	Area (m²)	Height (m)	Age Range	Capacity	Weight (kg)	Material	Finish	Coating	Material	Material
KK-11.20	-	6,9x4,0x3,1	85,6	3,0	7-14	10	514	•	α	-	-	•





KK-11.21

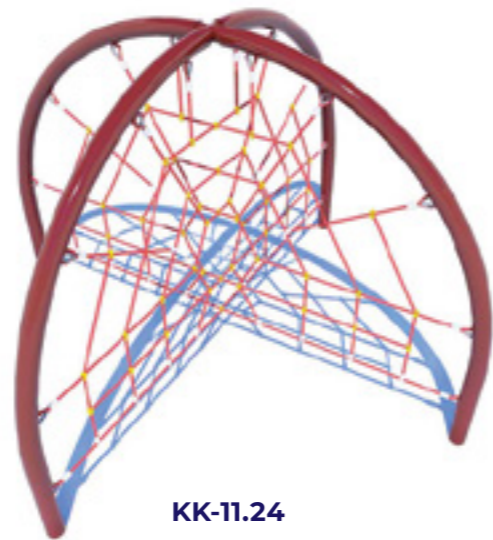

KK-11.24



KK-11.25



KK-11.26

	A	♿	📐	📐	📐	👤	👤+	📊	●	○	-	HDPE	HPL
KK-11.21	-		4,6x1,6x2,4	48,8	2,4	7-14	10	215	●	○	-	-	-
KK-11.24	-		3,74x3,74x2,4	59,9	2,7	7-14	10	198	●	○	-	-	-
KK-11.25	-		5,3x1,5x2,7	51	2	7-14	9	134	●	○	-	-	-
KK-11.26	-		3,96x0,9x1,55	38,9	<0,60	7-14	6	107	●	○	-	-	-



KK-11.27

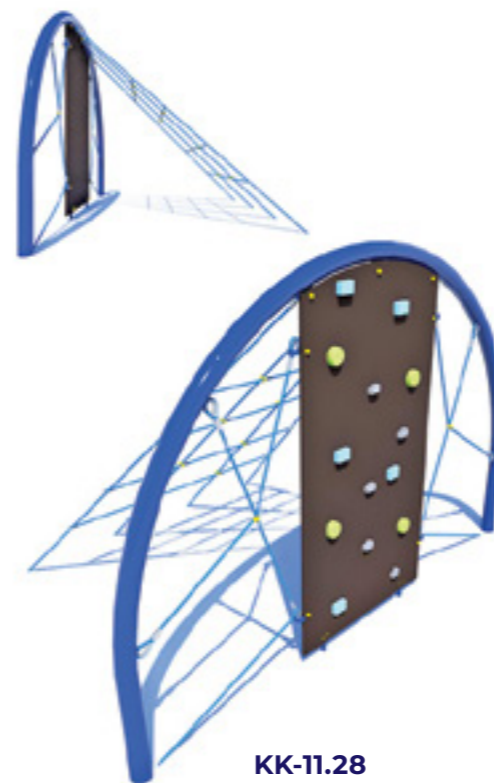

KK-11.28

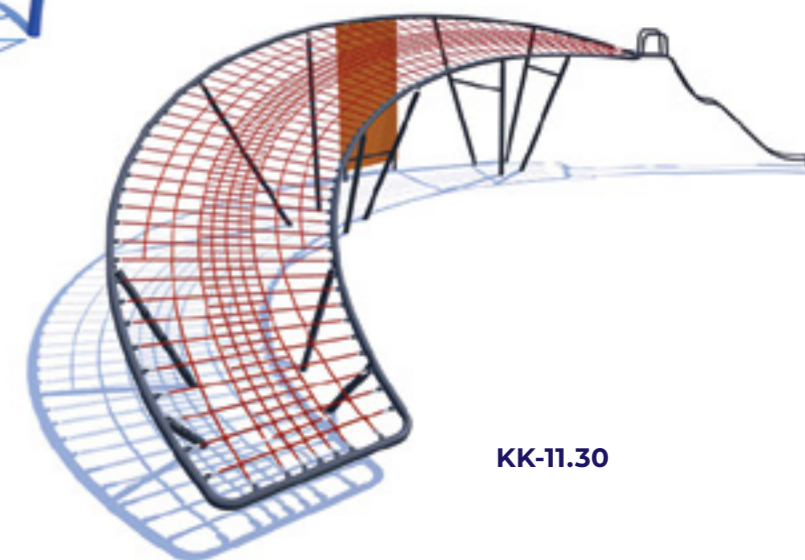

KK-11.30

	A	♿	📐	📐	📐	👤	👤+	📊	●	○	●	○	○
KK-11.27	-		3,71x0,1x2,7	31,8	2,7	7-14	8	153	●	○	●	○	○
KK-11.28	-		3,7x2,5x2,45	50	2,45	7-14	8	229	●	○	●	○	○
KK-11.30	-		12,9x6,6x2,83	179,3	2,8	7-14	36	1032	●	○	-	○	○









KK-11.32

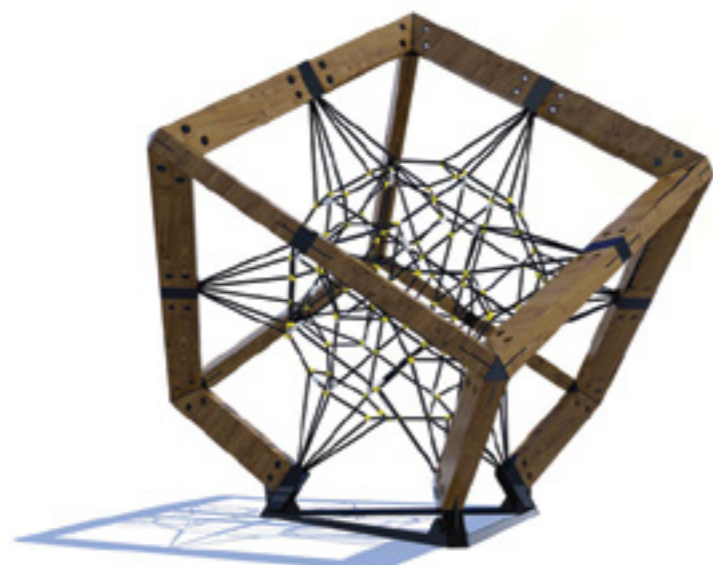

KK -11.33

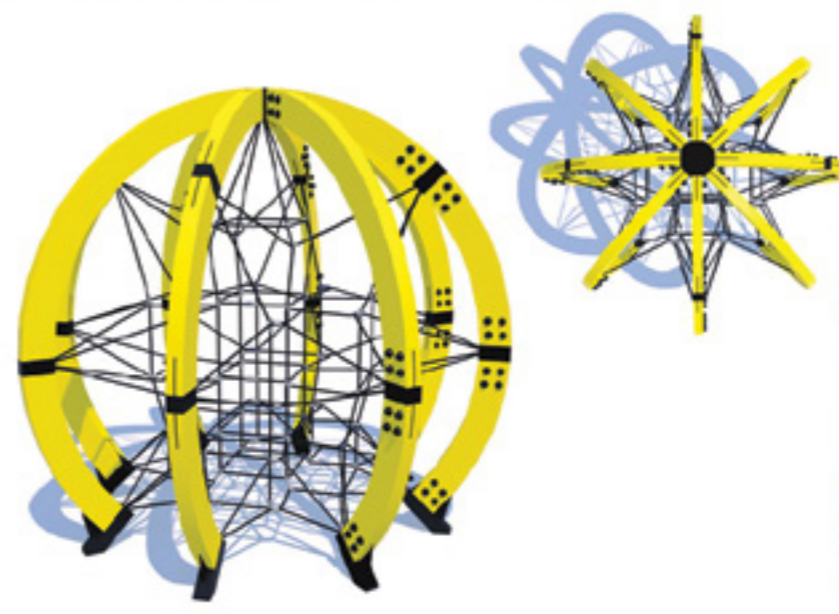

KK -11.34

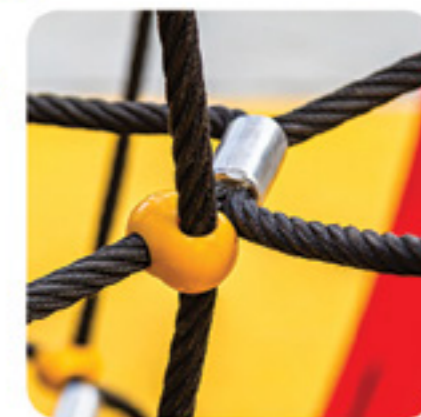

											HDPE	HPL
KK-11.32	-	1,8x1,8x2,63	53	2,5	7-14	8	331	•	o	-	-	-
KK -11.33	-	3,36x2,91x2,93	50,8	2,93	7-14	12	574	•	-	•	-	-

											HDPE	HPL
KK -11.34	-	3,36x3,36x2,98	85	2,98	7-14	12	1 000	•	•	•	-	-





KK -11.40

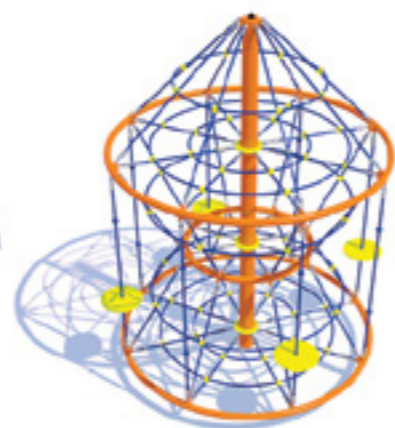

KK -11.46

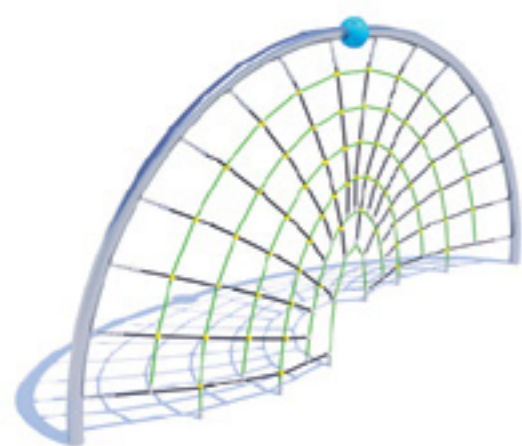

KK -11.48

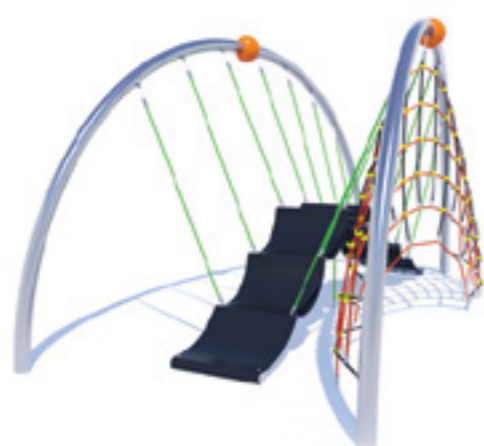

KK -11.49

	A	♿	📖	📐	📐	👤	👤+	📏	●	○	-	HDPE	HPL
KK -11.40	-							574	●	○	-	-	-
KK -11.46	-							151	●	○	-	-	-
KK -11.48	-							148	●	○	-	-	-
KK -11.49	-							313	●	○	-	-	-

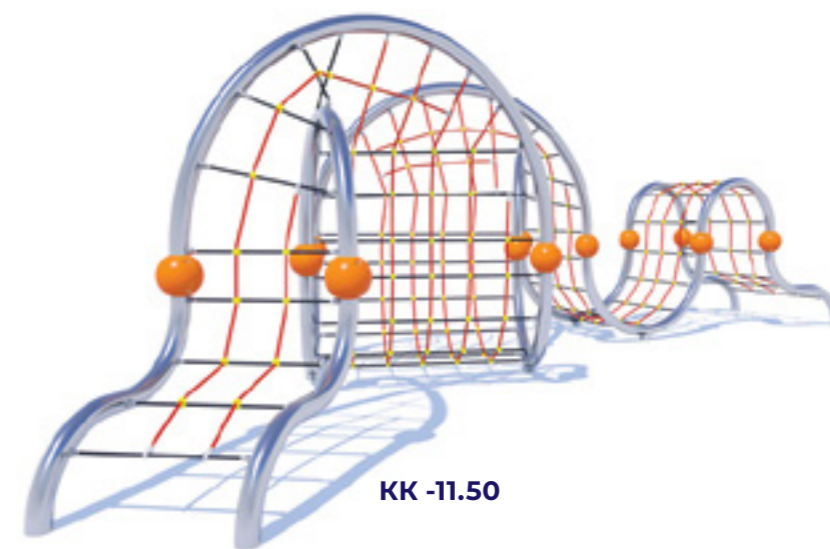

KK -11.50

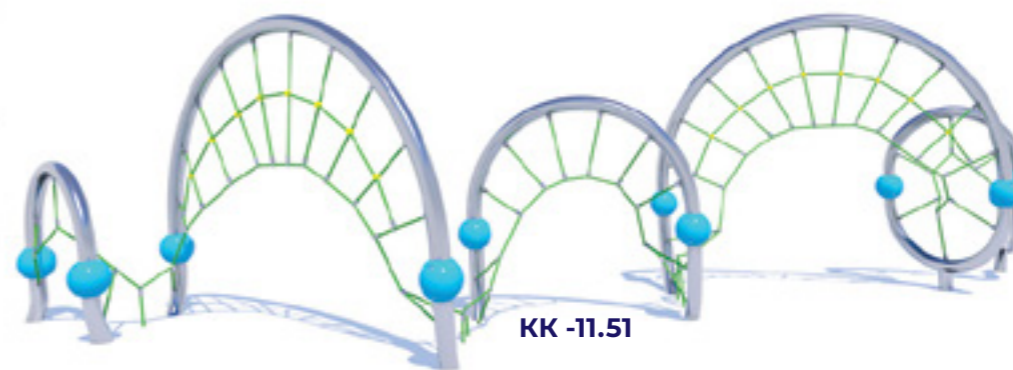

KK -11.51

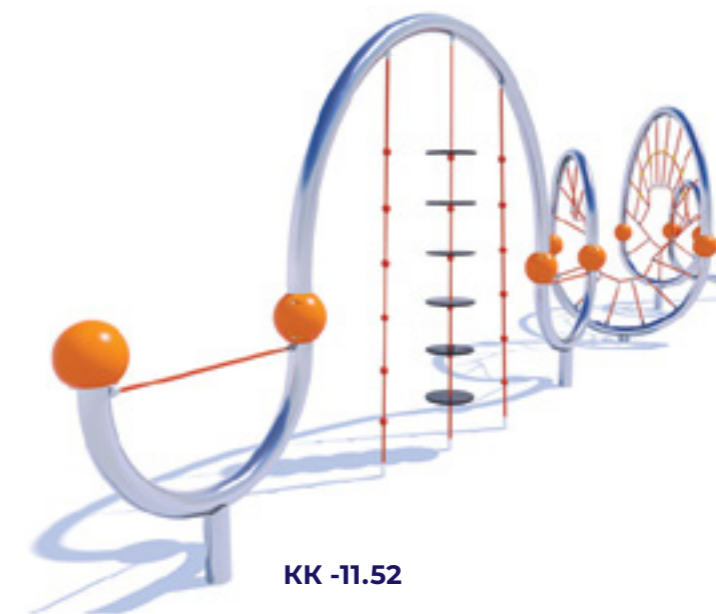

KK -11.52

	A	♿	📖	📐	📐	👤	👤+	📏	●	○	-	HDPE	HPL
KK -11.50	-							628	●	○	-	-	-
KK -11.51	-							476	●	○	-	-	-
KK -11.52	-							416	●	○	-	-	-





**KK -11.55**

	A	♿	📐	📐	📐	👤	👤+	📊	●	○	🌳	HDPE	HPL
KK -11.53	-		4,85x0,88x2,35	43,2	1	7-14	4	132	●	○	-	-	-
KK -11.54	-		9,7x7,2x2,6	154	2,6	7-14	30	1100	●	○	-	-	-
KK -11.55	-		5,8x5,8x2,7	96	2,6	7-14	20	776	●	○	-	-	-

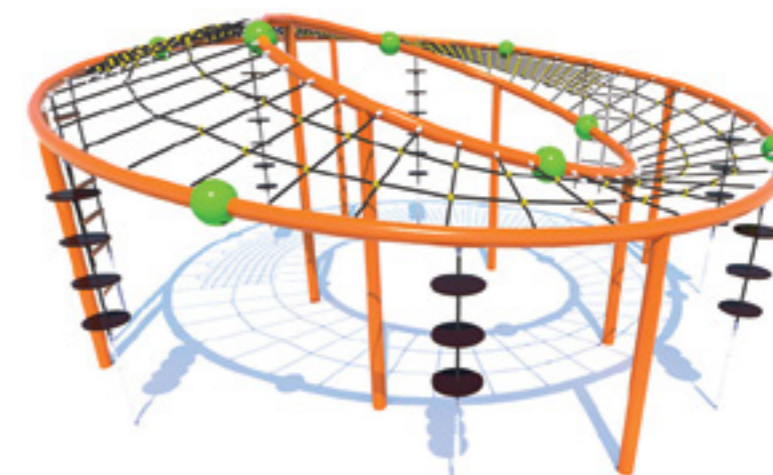
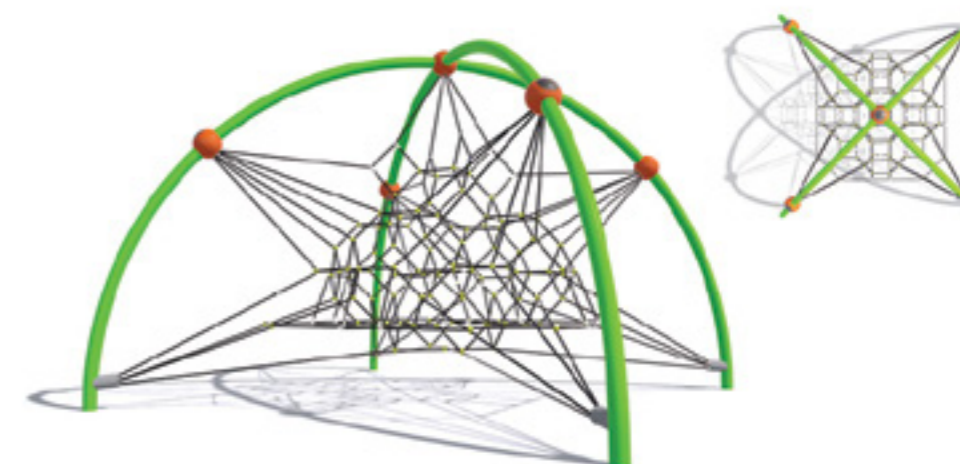

	A	♿	📐	📐	📐	👤	👤+	📊	●	○	🌳	HDPE	HPL
KK -11.56	-		6,2x6,2x3,1	106	3,1	7-14	16	324	●	○	-	-	-
KK -11.57	-		6,6x6,5x2,28	111	2,28	7-14	30	760	●	○	-	-	●

Характеристики розділу КАНАТНІ КОМПЛЕКСИ/ Characteristics of the section ROPE COMPLEXES

- Конструкція, елементи з оцинкованої або пофарбованої сталі**  
 Construction, elements from galvanized or painted steel
- Деталі з нержавіючої сталі**  
 Stainless steel construction or elements
- Мотузки зі сталевим сердечником**  
 Ropes with steel core
- Обертові елементи**  
 Spinning elements
- Ланцюжки з нержавіючої сталі**  
 Stainless steel chains
- Захисні верхи**  
 Protective tops

\* Варіанти матеріалів стосуються вибраних продуктів, для отримання додаткової інформації відвідайте [www.goida-da.com](http://www.goida-da.com)  
 \* Material options apply to selected products, for more information visit [www.goida-da.com](http://www.goida-da.com)



## Еко/Есо

Міське життя, велика кількість бетону та асфальту віддаляють дітей від цілющої сили всього живого. На жаль, зміна обстановки з виїздом у ліс не всім доступна. Гідною альтернативою виступає екостиль в оформленні дитячого містечка – якщо ви не йдете до природи, то створіть її у себе у дворі. Занурення в природу – це можливість перемикнути та насититися внутрішньою енергією. Такий дизайн зробить дитячий майданчик по-справжньому затишним та комфортним. Екостиль натхненний і сповнений гармонії самої природи, а також уособлює дбайливе до неї ставлення.

City life, the abundance of concrete and asphalt alienate children from the healing power of all living things. Unfortunately, a change of scenery with a trip to the forest is not available to everyone. A worthy alternative is the eco-style in the design of the children's town - if you do not go to nature, then create it in your yard. Immersion in nature is an opportunity to switch gears and get enough inner energy. This design will make the playground truly cozy and comfortable. The eco-style is inspired by the harmony of nature itself and embodies a careful attitude towards it.



KR-01

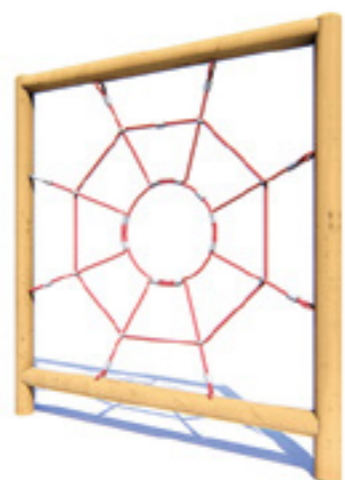

KR-02



KR-03



KR-04



Model	Age	Dimensions (LxWxH)	Weight	Height	Age Range	Capacity	Weight	Material 1	Material 2	Material 3	Material 4	Material 5
KR-01	-	2,45x1,1x1,5	33	<0,6	3-12	4	198	-	●	●	-	-
KR-02	-	2,14x0,15x2,0	25,48	2	3-12	4	104	-	●	●	-	-
KR-03	-	2,3x0,9x1,8	100	1,5	3-12	2	100	-	●	●	-	-
KR-04	-	2,3x0,18x0,8	26,1	0,7	3-12	2	49	-	●	●	-	-







KR-05

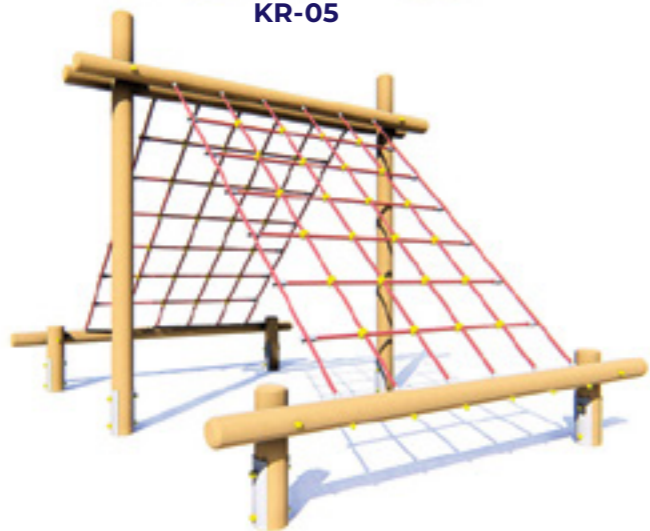

KR-09



	A	♿	📏	📐	👤	👤+	📊	📏	📏	📏	📏	HDPE	HPL
KR-05	-		4,0x3,4x0,4	-	< 0,6	3-12	20	500	-	-	-	●	-
KR-09	-		3,6x2,6x2,45	48,6	2	3-12	12	132	-	-	●	●	-

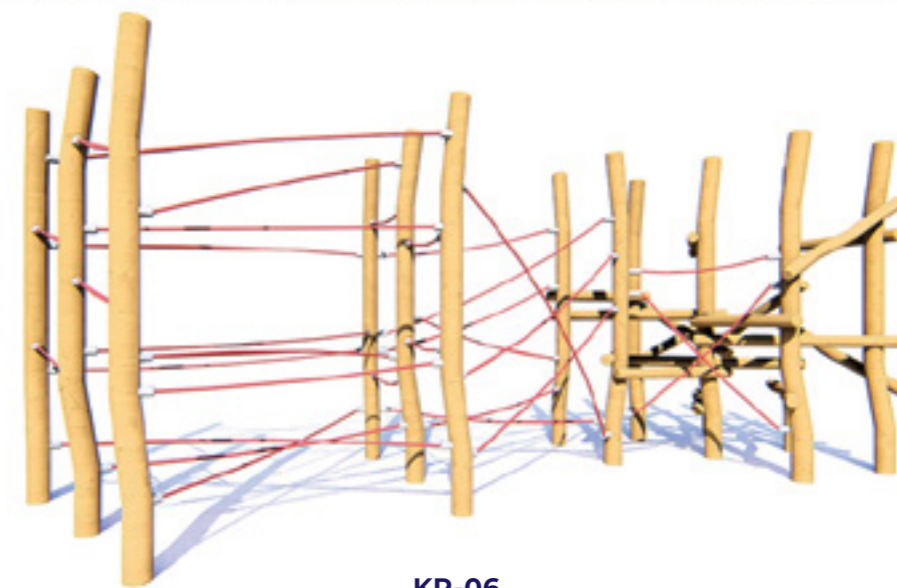

KR-06

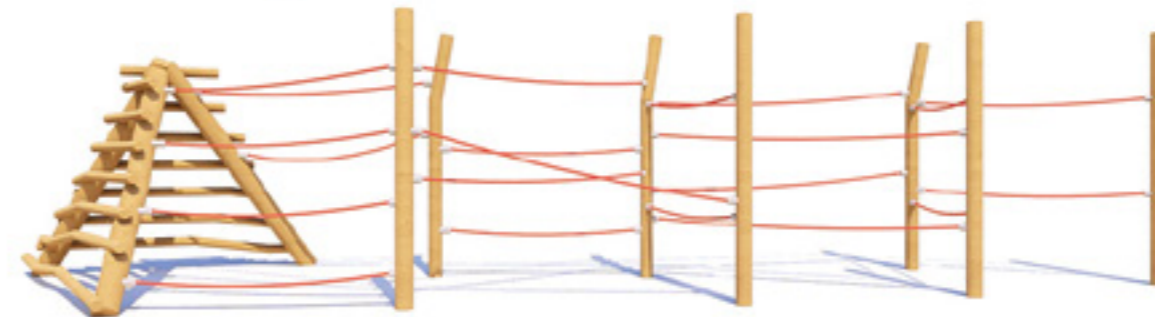

KR-11

	A	♿	📏	📐	👤	👤+	📊	📏	📏	📏	📏	HDPE	HPL
KR-06	-		6,4x2,9x2,7	71,7	2	3-12	18	547	-	●	●	-	-
KR-11	-		9,0x2,3x1,95	-	2	3-12	15	200	-	●	●	-	-





	A	♿	📐	📐	📐	👤	👤+	📊	📊	📊	HDPE	HPL
KR-08	-		3,7x1,5x0,5	42,3	<0,6	3-12	3	265	-	●	●	-
KR-12	-		4,68x0,9x3,2	42,5	2,5	3-12	5	313	-	-	●	-

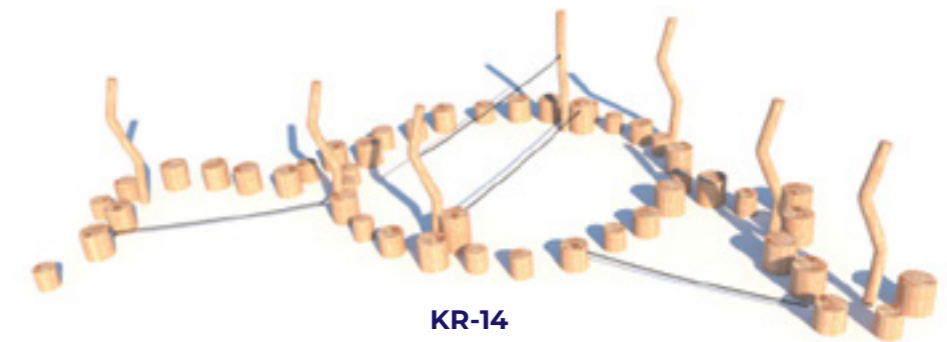

KR-14



KR-16



KR-13



KR-17



	A	♿	📐	📐	📐	👤	👤+	📊	📊	📊	HDPE	HPL
KR-13	-		4,2x3,7x0,5	<0,6	<0,6	3-12	16	320	-	●	●	-
KR-14	-		11,4x6,6x2,0	<0,6	<0,6	3-12	32	1000	-	●	●	-
KR-16	-		2,1x1,2x2,4	1,3	1,3	3-12	1	175	-	●	●	-
KR-17	-		4,0x1,46x2,7	43,6	1,3	3-12	2	205	-	●	●	-



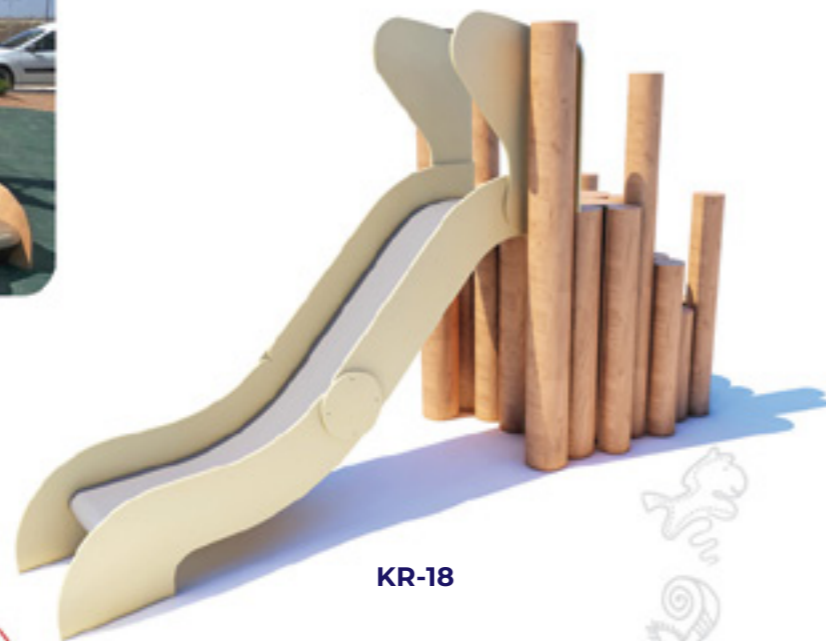

KR-18



KR-19



	A	♿	📺	📺	📺	👤👤	👤👤	📊	📊	📊	📊	HDPE	HPL					
KR-18	-							3,8x1,7x2,0	54,8	1,7	3-12	2	560	1,2	-	-	-	-
KR-19	-							6,7x4,9x1,9		< 0,6	3-12	20	670	-	-	-	-	-







	A	♿	📏	📏	📏	👤	👤+	📊	🔲	🔲	🌳	HDPE	HPL
KRN-01	-	0,18x0,18x0,3	-	< 0,6	3-12	1	12	-	●	●	-	-	-
KRN-02	-	0,9x0,45x0,26	21,8	< 0,6	3-12	2	27	-	●	●	-	-	-
KRN-03	-	3,54x0,26x0,5	32,1	< 0,6	3-12	3	40	-	●	●	-	-	-
KRN-04	-	2,09x0,67x0,32	28,4	< 0,6	3-12	5	72	-	●	●	-	-	-
KRN-05	-	3,89x0,18x0,5	33	< 0,6	3-12	6	63	●	●	●	-	-	-
KRN-06	-	3,0x0,18x0,5	29,2	< 0,6	3-12	5	61	-	●	●	-	-	-
KRN-07	-	4,52x1,64x0,66	48	0,63	3-12	11	110	-	●	●	-	-	-
KRN-08	-	6,0x2,49x0,61	70	0,65	3-12	16	159	-	●	●	-	-	-





KRN-09

KRN-10

KRN-11



KRN-12

KRN-13

KRN-14



KRN-17



KRN-15

KRN-16



Model	Dimensions (LxWxH)	Weight (kg)	Height (m)	Age Group	Capacity	Load (kg)	Material 1	Material 2	Material 3	Material 4	Material 5	Material 6
KRN-09	2,88x1,35x1,29	36,8	< 0,6	3-12	4	170	-	•	•	-	-	-
KRN-10	2,68x0,18x0,4	28	< 0,6	3-12	6	59	-	•	•	-	-	-
KRN-11	1,98x1,44x2,37	32,5	2,37	3-12	6	140	-	•	•	-	-	-
KRN-12	2,5x0,31x1,5	28	< 0,6	3-12	5	91	-	•	•	-	-	-
KRN-13	3,74x0,45x1,6	34,4	< 0,6	3-12	5	150	-	•	•	-	-	-
KRN-14	2,25x0,7x0,34	29,3	< 0,6	3-12	5	112	-	•	•	-	-	-
KRN-15	2,0x1,68x1,05	35,2	1	3-12	3	192	-	•	•	-	-	-
KRN-16	3,18x2,0x1,19	43	1,17	3-12	16	252	-	•	•	-	-	-
KRN-17	5,07x2,36x1,75	57,7	0,9	3-12	11	191	-	•	•	-	-	-



KRN-19



KRN-20



KRN-21



KRN-22



Model	Dimensions (LxWxH)	Weight (kg)	Height (m)	Age Group	Capacity	Load (kg)	Material 1	Material 2	Material 3	Material 4	Material 5	Material 6
KRN-19	9,37x8,71x4,39	170	2,4	6-12	28	1202	2,1; 1,8	-	•	•	-	-
KRN-20	6,9x4,38x4,39	91,3	2,4	6-12	22	707	2,1	-	•	•	-	-
KRN-21	4,7x3,35x3,7	64,4	1,5	6-12	10	295	1,5	-	•	•	-	-
KRN-22	2,37x2,33x2,2	40,3	< 0,6	1-12	9	282	-	-	•	•	-	-





KRN-23



KRN-24



KRN-25



KRN-26



KRN-27



KRN-28



KRN-29



KRN-30



KRN-31



KRN-32



KRN-33



KRN-34

	A	♿	📏	📏	👤	👤+	📊	📏	📏	📏	📏	HDPE	HPL
KRN-23	-		9,37x7,99x4,39	148,3	2	6-12	28	1148	1,8	-	•	•	-
KRN-24	-		3,67x2,67x2,9	51,6	0,9	3-12	11	396	0,9	-	•	•	-
KRN-25	-		1,61x1,2x1,15	29,1	< 0,6	1-12	11	180	-	-	•	•	-
KRN-26	-		1,63x1,2x1,15	29,2	< 0,6	1-12	10	155	-	-	•	•	-
KRN-27	-		4,13x1,71x1,55	46,4	< 0,6	1-12	25	338	-	-	•	•	-
KRN-28	-		2,63x1,21x2,17	34,5	< 0,6	1-12	12	269	-	-	•	•	-

	A	♿	📏	📏	👤	👤+	📊	📏	📏	📏	📏	HDPE	HPL
KRN-29	-		2,33x1,5x2,0	34,8	< 0,6	1-12	8	200	-	-	•	•	-
KRN-30	-		1,5x1,43x2,0	29,8	< 0,6	1-12	4	172	-	-	•	•	-
KRN-31	-		1,2x1,2x1,7	27,6	< 0,6	1-12	4	149	-	-	•	•	-
KRN-32	-		3,36x2,08x3,09	47,7	0,9	3-12	8	310	0,9	-	•	•	-
KRN-33	-		3,4x3,5x3,09	44,6	0,9	3-12	9	390	0,9	-	•	•	-
KRN-34	-		5,5x3,3x3,09	75,6	0,9	3-12	21	650	0,9	-	•	•	-





KRN-35



KRN-36



KRN-37



KRN-38



KRN-39



KRN-40



KRN-41



KRN-42



KRN-43



KRN-44



KRN-45

	A	♿	📖	📐	👤	👤+	📊	📏	📏	📏	HDPE	HPL	
KRN-35	-	6,25x2,64x2,5	68	1,3	3-12	8	288	1,2	●	●	●	-	-
KRN-36	-	2,8x1,78x2,2	39,3	0,9	3-12	5	155	0,9	●	●	●	-	-
KRN-37	-	3,98x3,56x2,2	60,3	1,7	3-12	12	228	0,9	●	●	●	-	-
KRN-38	-	6,4x3,77x2,5	80,8	2	3-12	22	445	1,2	●	●	●	-	-
KRN-39	-	4,79x2,6x4,0	58	0,9	3-12	12	229	-	●	●	●	-	-

	A	♿	📖	📐	📏	👤	👤+	📊	📏	📏	📏	HDPE	HPL
KRN-40	-	3,8x2,9x3,0	54	1,1	3-12	6	250	0,9	●	●	●	-	-
KRN-41	-	3,15x1,54x1,58	53,9	1,1	3-12	9	161	-	●	●	●	-	-
KRN-42	-	3,86x1,29x3,5	42	1,1	3-12	9	290	-	●	●	●	-	-
KRN-43	-	5,98x1,63x3,5	56	1,1	3-12	8	314	-	●	●	●	-	-
KRN-44	-	3,0x2,38x4,0	45	1,5	6-12	3	210	-	●	●	●	-	-
KRN-45	-	8,1x3,4x4,0	90	0,9	6-12	20	640	0,9	●	●	●	-	-



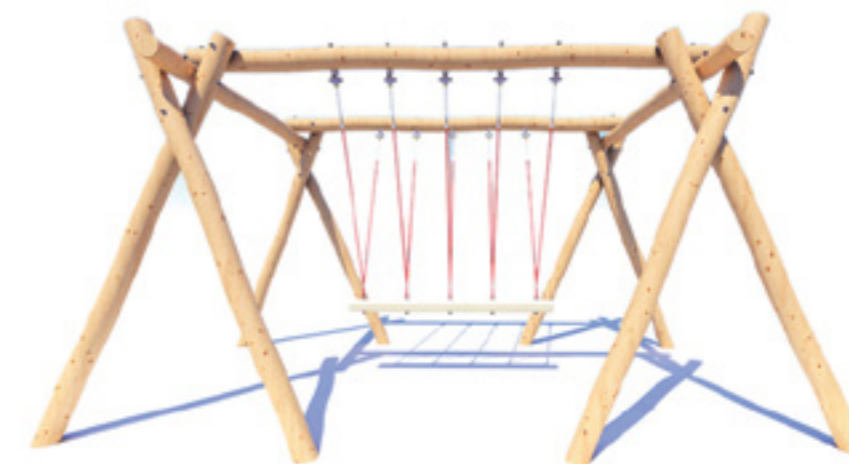

KRN-46

KRN-46	-	7,0x3,6x2,96	84	1,3	6-12	4	660	-	•	•	•	-	-

Характеристики розділу ЕКО/ Characteristics of the section ECO

- Деталі із акації  
Details from robinia
- Деталі з нержавіючої сталі  
Stainless steel construction or elements
- HPL панелі  
HPL panels
- Мотузки зі сталевим сердечником  
Ropes with steel core
- Гірки із нержавіючої сталі  
Stainless steel slides
- Ланцюжки з нержавіючої сталі  
Stainless steel chains
- Обертові елементи  
Spinning elements

\* Варіанти матеріалів стосуються вибраних продуктів, для отримання додаткової інформації відвідайте [www.goida-da.com](http://www.goida-da.com)  
\* Material options apply to selected products, for more information visit [www.goida-da.com](http://www.goida-da.com)



# Спортивне обладнання дитячих майданчиків/ Sports equipment for playgrounds

Спортивне обладнання вважається одним із найцікавіших та видовищних елементів на дитячому майданчику. Граючи можна не тільки весело та корисно провести час, а й тримати тіло в тонусі. Рухливі ігри, як відомо, мають позитивний вплив на здоров'я. Розвивають витривалість, спритність, разом із фізичними навантаженнями гарантують гарне самопочуття.

Sports equipment is considered one of the most interesting and spectacular elements on the playground. While playing, you can not only have a fun and useful time, but also keep your body in good shape. Active games are known to have a positive effect on health. They develop endurance, dexterity, and together with physical exertion, they guarantee good health.



SO-9.01.01



SO-9.46



SO-9.01



SO-9.47

	A	♿	📖	👤	👤+	📖	HDPE	HPL
SO-9.01.01	-	2,0x1,0x3,0	7+	1	125	●	●	●
SO-9.01	-	1,8x1,95x3,94	7+	1	100	●	●	●
SO-9.46	-	1,2x0,9x0,64	7+	1	31	●	●	●
SO-9.47	-	1,8x1,05x0,64	7+	1	36	●	●	●



SO-9.03



SO-9.04



SO-9.04.03



SO-9.04.04



	A	♿	📖	👤	👤+	📖	HDPE	HPL
SO-9.03*	-	0,05x0,12x2,5	7+	1	36	●	-	-
SO-9.04*	-	7,53x1,57x2,58	7+	1	148	●	-	-
SO-9.04.03*	-	5,08x1,45x2,08	7+	1	112	●	-	-
SO-9.04.04*	-	3,2x1,3x2,15	7+	1	98	●	-	-

\* Можливе комплектування моделей сітками/ It is possible to complete the models with grids





SO-9.05\*

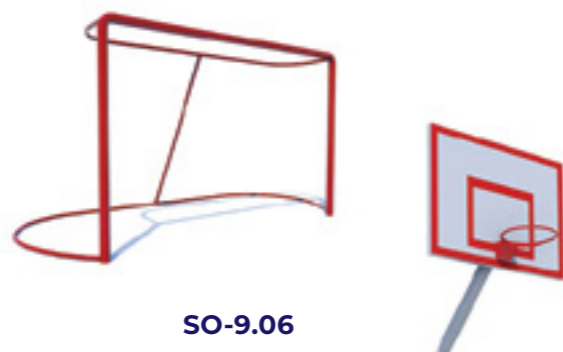

SO-9.06

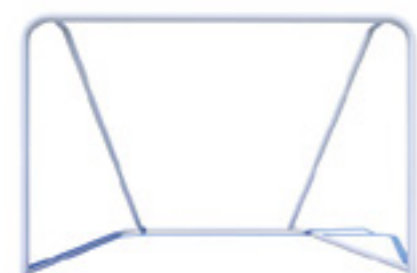

SO-9.07



SO-9.40



Model	Dimensions	Age	Weight	Material	Surface	Grid	HDPE	HPL
SO-9.05**	3,3x1,0x2,2	7+	98	•	-	-	-	-
SO-9.06**	2,5x1,15x1,25	7+	98	•	-	-	-	-
SO-9.07**	1,55x0,75x1,0	7+	15	•	-	-	-	-
SO-9.40**	3,2x1,94x3,7	7+	201	•	-	•	-	-

\* Розфарбовування воріт у вартість моделі не входить / Gate painting is not included in the price of the model  
 \*\* Можливе комплектування моделей сітками / It is possible to complete the models with grids

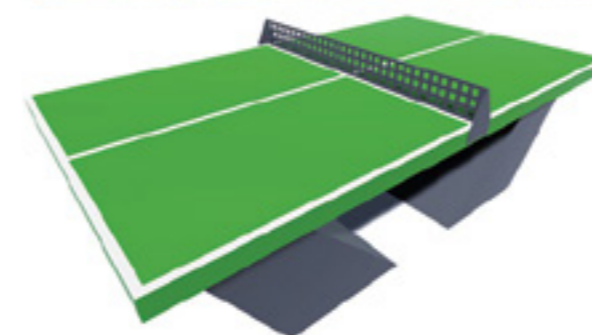

SO-9.66



SO-9.08



SO-9.76



SO-9.77



Model	Dimensions	Weight	Thickness	Age	Weight	Material	Surface	Grid	HDPE	HPL
SO-9.08	2,74x1,52x0,76	36,5	0,7	7+	4	120	•	-	•	-
SO-9.66	2,73x1,53x0,92	37,2	0,9	7+	4	1028	•	-	•	-
SO-9.76	3,0x1,7x0,76	36,5	0,7	7+	4	185	•	-	•	•
SO-9.77	2,7x1,5x0,76	36,5	0,7	7+	4	185	•	-	•	•





SO-9.25



SO-9.13

SO-9.13.2

SO-9.14



SO-9.15

	A	♿	📐	📐	📐	👤	👤+	📊	🔲	🔲	🌳	HDPE	HPL
SO-9.13	-							53	●	-	●	-	-
SO-9.13.2	-							54	●	-	●	-	-
SO-9.14	-							35	●	-	●	-	-
SO-9.25	-							40	●	-	●	-	-

	A	♿	📐	📐	📐	👤	👤+	📊	🔲	🔲	🌳	HDPE	HPL
SO-9.15	-							129	●	-	●	-	-





SO-9.09

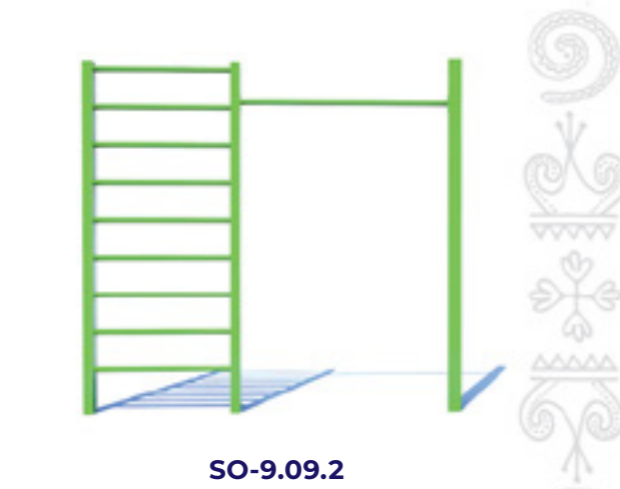

SO-9.09.2

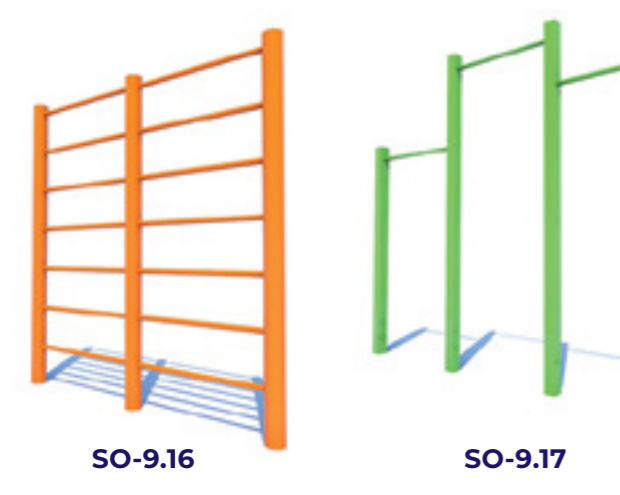

SO-9.16

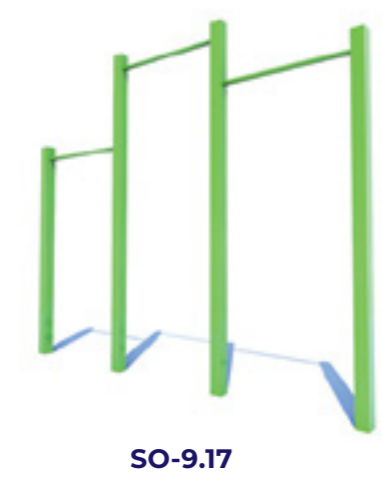

SO-9.17



SO-9.19.1

Model	Material	Dimensions (mm)	Weight (kg)	Height (m)	Age Group	Capacity (people)	Load (kg)	Color	Surface	Material	Material
SO-9.09	-	6,05x0,1x2,3	-	2,15	7+	5	216	●	-	-	-
SO-9.09.2	-	2,33x0,06x2,15	25,7	2,15	7+	2	60	●	-	-	-
SO-9.16	-	1,9x0,06x2,15	29,8	2,15	7+	2	80	●	-	-	-
SO-9.17	-	4,22x0,08x2,29	33,5	1,3	7+	3	86	●	-	-	-
SO-9.19.1	-	2,97x1,17x2,4	-	1,4	7+	1	47	●	-	-	-

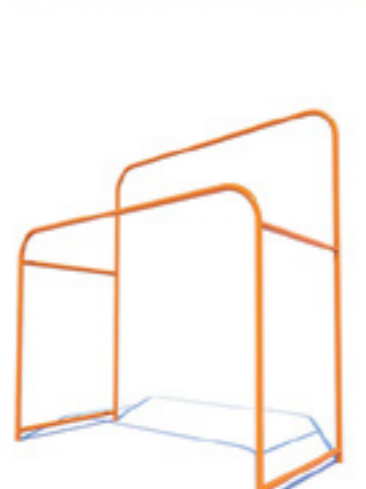

SO-9.20



SO-9.21



SO-9.27

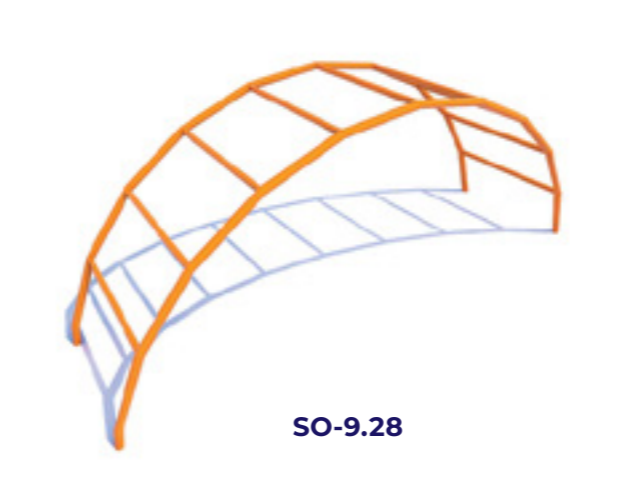

SO-9.28

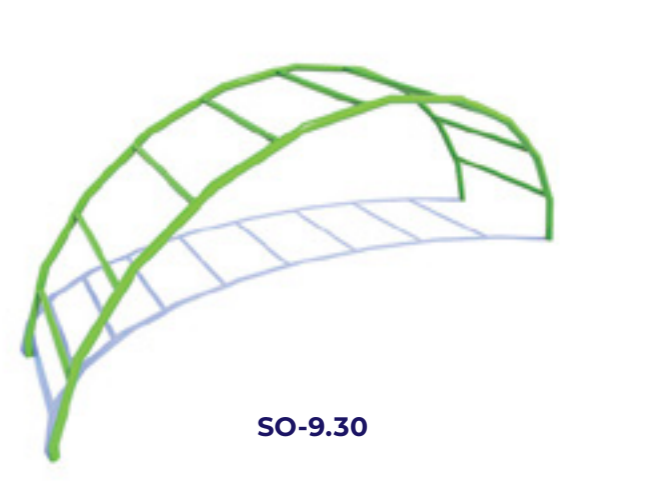

SO-9.30

Model	Material	Dimensions (mm)	Weight (kg)	Height (m)	Age Group	Capacity (people)	Load (kg)	Color	Surface	Material	Material
SO-9.20	-	2,0x0,93x2,2	32	2,15	7+	2	52	●	-	-	-
SO-9.21	-	2,6x0,65x1,5	29,4	1,5	7+	1	44	●	-	-	-
SO-9.27	-	3,0x0,6x1,5	-	1,5	7+	1	49	●	-	-	-
SO-9.28	-	2,4x0,6x0,9	30,6	0,8	7+	1	35	●	-	-	-
SO-9.30	-	2,63x0,63x1,02	31,5	1	7+	1	30	●	-	-	-





SO-9.29



SO-9.22



SO-9.32

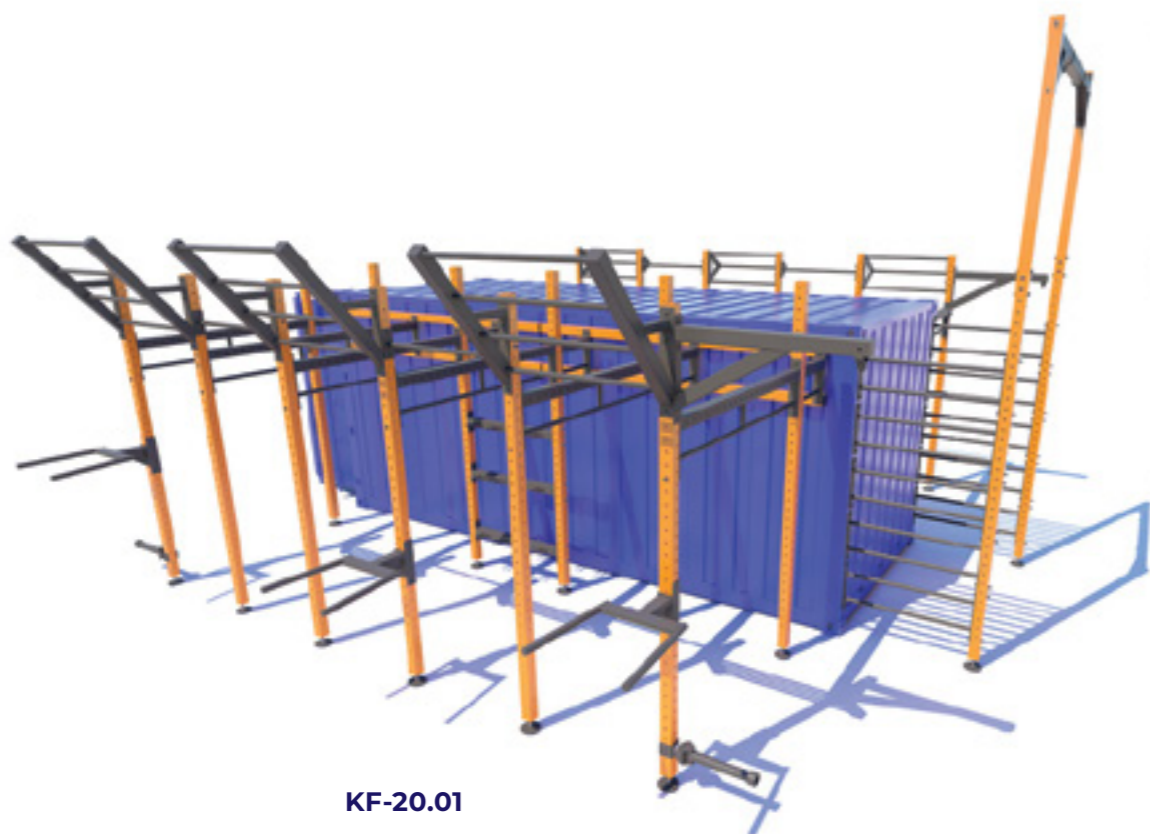

KF-20.01

	A	♿	📏	📏	📏	👤	👤+	📊	🔲	🔲	🌳	HDPE	HPL
SO-9.22	-		2,0x0,7x0,5	28,2	0,8	7+	3	36	●	-	●	-	-
SO-9.32	-		3,0x0,66x0,65	32,6	0,65	7+	4	39	●	-	-	-	-
SO-9.29	-		1,35x0,65x2,35	-	-	-	1	71	●	-	●	-	-
KF-20.01	-		8,5x8,0x4,6	-	2,8	7+	18	5 000	●	-	-	-	-



SO-9.33



SO-9.36



SO-9.38

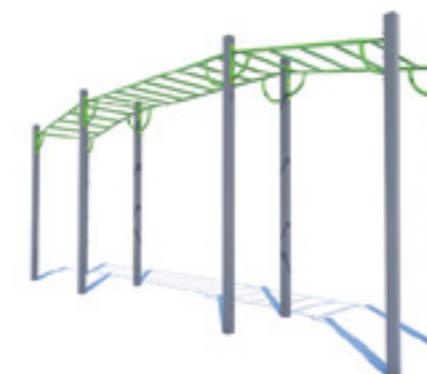

SO-9.39



SO-9.51

	A	♿	📏	📏	📏	👤	👤+	📊	🔲	🔲	🌳	HDPE	HPL
SO-9.33	-		2,30x1,0x2,1	31,5	2,1	7+	2	93	●	-	●	o	o
SO-9.36	-		1,5x0,8x2,3	-	2,3	7+	2	80	●	-	-	-	-
SO-9.38	-		2,3x0,85x2,8	-	2,8	7+	3	96	●	-	-	-	-
SO-9.39	-		6,6x1,0x2,6	53	1,6	7+	1	260	●	-	-	-	-
SO-9.51	-		4,5x1,8x1,5	49,3	1,2	7+	1	120	●	-	-	-	-



# Трибуни/Tribunes

Будь-який спортивний чи культурний захід, що проводиться на стадіоні, завжди супроводжується присутністю глядачів. І одним із важливих питань, що стоять перед організаторами, є зручне та безпечне розміщення пересічних громадян, які бажають насолодитися майбутнім видовищем; учасників змагань; спортивних суддів; медичних працівників; тренерського складу та інших відповідальних осіб. Для цього використовують трибуни для спортивних залів і стадіонів.

Any sports or cultural event held at the stadium is always accompanied by the presence of spectators. And one of the important issues facing the organizers is the convenient and safe accommodation of ordinary citizens who want to enjoy the upcoming spectacle: competition participants; sports referees; medical workers; coaching staff and other responsible persons. Tribunes for sports halls and stadiums are used for this.



SO-9.52



SO-9.53



SO-9.55

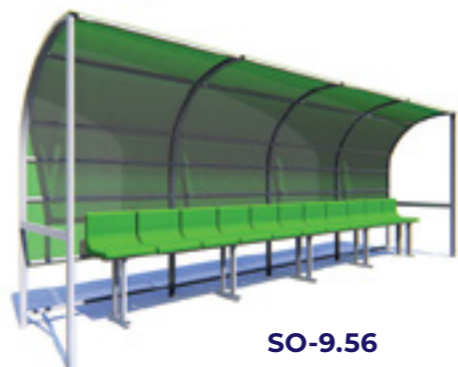

SO-9.56



SO-9.57



SO-9.58



Model	Color	Dimensions (LxWxD)	Capacity	Weight	Material 1	Material 2	Material 3	Material 4	Material 5	Material 6
SO-9.52	-	6,1x2,1x2,0	30	790	●	-	-	-	-	-
SO-9.53	-	9,2x2,1x2,0	50	1115	●	-	-	-	-	-
SO-9.55	-	9,3x2,8x3,68	50	2406	●	-	-	-	-	-
SO-9.56	-	5,45x0,96x2,4	11	1110	●	-	-	-	-	-
SO-9.57	-	4,76x2,09x1,99	21	730	●	-	-	-	-	-
SO-9.58	-	9,3x2,8x3,68	36	2406	●	-	-	-	-	-



T-1.000

T-2.000



T-3.000



Model	Color	Dimensions (LxWxD)	Capacity	Weight	Material 1	Material 2	Material 3	Material 4	Material 5	Material 6
T-1.000	-	2,4x0,5x0,8	5	44,0	●	-	-	-	-	-
T-2.000	-	1,9x0,5x0,8	4	37,0	●	-	-	-	-	-
T-3.000	-	2,4x1,2x1,16	10	136,0	●	-	-	-	-	-







# Військово-спортивна смуга перешкод / Military sports obstacle course

Устаткування для допризовної підготовки юнаків (ДПЮ). Призначена для розвитку фізичної форми підлітків, здобуття навичок подолання типових перешкод, розвиток реакції, витривалості та спритності.

Equipment for pre-conscription training of young men. Designed to develop the physical form of adolescents, gain skills to overcome typical obstacles, develop reaction, endurance and agility.



	A	♿	📖	📐	👤	👤+	📖	📖	📖	HDPE	HPL		
SO-9.60	-			84,7	2	7+	1	276	●	-	●	-	-
SO-9.61	-			58,2	1,8	7+	1	284	●	-	●	-	-
SO-9.62	-			28,6	1,1	7+	2	147	●	-	●	-	-
SO-9.63	-			43,8	2	7+	1	166	●	-	●	-	-





## Ігрові поля / Playing fields

PANNA – новий вид вуличного футболу, де головною метою є не забити м'яч у ворота, а прокинути його між ніг суперника. Головний критерій тут – це виконання «фінтів» для перемоги. Гра проходить у форматі віч-на-віч, «клітина» як ще називають майданчик для панни, служить свого роду рингом. Найчастіше виготовлена з металу та має круглу форму. ТМ ГОЙДА надає великий вибір форм, з огорожею з лозин або сітки. Існують різні варіанти висоти сіток, можлива наявність воріт.

PANNA is a new type of street football where the main goal is not to hit the ball into the gates, but to throw it between the opponent's legs. The main criterion here is to perform «tricks» to win. The game is played in a face-to-face format, and the «cage», as the playground is also called, serves as a kind of ring. Most often it is made of metal and has a round shape. TM GOIDA offers a wide range of shapes, with a fence made of wicker or mesh. There are various options for the height of the mesh, and gates are available.



OF-1

Штучна трава/  
Artificial grass



**Зверніть увагу!**  
Види внутрішнього покриття/  
Pay attention!  
Types of internal coating

Гумове покриття/  
Rubber cover



									HDPE	HPL
OF-1	-	5,4x6,06x1,9	7+	2	460	•	•	•	-	-



Молодь обирає ПАННУ!

## ПРАВИЛА ПАННА-ФУТБОЛУ

### ЩО ТАКЕ ПАННА?

Панною вважається навмисний кидок м'яча між ніг суперника. На розсуд організаторів турніру, панна може зараховуватися двома різними способами: зі збереженням і без збереження контролю м'яча атакуючим гравцем. Збереження контролю м'яча означає, що атакуючий гравець, виконавши панну, повинен першим торкнутися м'яча, або м'яч повинен потрапити в ворота. Панна може бути зроблена в будь-якому напрямку: вперед, назад і вбік. Положення ніг гравця у захисту не має значення (одна нога може перебувати перед іншою). Під час кидка дозволяється дотик до ніг суперника або бортів майданчика.

### ПАННА В ФОРМАТІ 1x1

1. Гра ведеться сам на сам.
2. На початку гри, гравці встають спина до спini та затискають м'яч між собою. За сигналом судді гравці розгортаються і починають гру.
3. Загальна тривалість гри - 3 хвилини «брудного» часу.
4. Голи зараховуються тільки в тому випадку, якщо удар був проведений з половини поля опонента.
5. Гравець, який забив гол, зобов'язаний повернутися на свою половину поля.
6. Після закінчення трьох хвилин, переможець визначається найбільшою кількістю голів.
7. Панна, прокинута опоненту - чиста перемога. Після кидка панни оголошується нокаут, гра зупиняється.
8. Гра ведеться лицем до лица. Гравець, що володіє м'ячем, повинен атакувати ворота суперника, або створювати дії для кидка панни. Категорично забороняється «сушити» гру. Якщо протягом 10 секунд атакуючі дії не були застосовані - м'яч переходить до гравця, що обороняється.
9. У разі фолу, суддя передає м'яч опоненту, після того, як обидва учасники займуть місце біля своїх воріт.
10. У разі особливо жорстких фолів, а також багаторазових порушень правил, суддя має право покарати сторону порушника голом.

**Нарахування балів:** участь в турнірі - 1 бал, виграний матч - 3 бали, виграш панною - 4 бали, матч за 3-є місце - 1 бал за перемогу / 2 бали за панну. При рівній кількості балів гравці шикуються за алфавітом.

Грай в ПАННУ разом з ГОЙДА!

Young people choose PANNA!

## RULES OF PANNA-FOOTBALL

### WHAT IS A PANNA?

Panna is an intentional throw of the ball between the opponent's legs.

At the discretion of the tournament organizers, a panna can be scored in two different ways: with or without the attacking player keeping control of the ball.

Keeping control of the ball means that the attacking player who performed a panna, must be the first to touch the ball, or the ball must go into the goal.

The panna can be made in any direction: forward, backward and sideways. The position of the player's legs in defense does not matter (one leg can be in front of the other)

During the throw, it is allowed to touch the opponent's legs or the sides of the court.

### PANNA IN 1x1 FORMAT

1. The game is played one on one.
2. At the beginning of the game, the players stand back to back and hold the ball between them. At the signal of the referee, the players turn around and start the game.
3. The total duration of the game is 3 minutes of «dirty» time.
4. Goals are scored only if the shot was taken from the opponent's half of the field.
5. The player who scored the goal must return to his own half of the field.
6. After three minutes, the winner is determined by the highest number of goals.
7. Panna, thrown to the opponent - a clean victory. After the throw of the panna is declared knockout, the game is stopped.
8. The game is played face to face. The player in possession of the ball must attack the opponent's gate or create actions to throw the panna. It is strictly forbidden to «dry» the game. If no attacking action is taken within 10 seconds, the ball goes to the defending player.
9. In case of a foul, the referee passes the ball to the opponent after both participants take a place near their gates.
10. In case of particularly severe fouls, as well as repeated violations of the rules, the referee has the right to punish the offending team with a goal.

**Scoring:** participation in the tournament - 1 point, won match - 3 points, won by a panna - 4 points, match for 3rd place - 1 point for winning / 2 points for panna. In case of an equal number of points, players are lined up alphabetically.

Play PANNA with GOIDA!



# Вуличні тренажери / Outdoor fitness equipment

Популяризація здорового життя на державному рівні спрямована на залучення різних верств населення до спорту. Це одна із причин появи у містах та інших населених пунктах дедалі більшої кількості спортивних майданчиків, на яких встановлені вуличні тренажери. З їх допомогою кожен охочий може безплатно та у будь-який зручний час прямо на вулиці виконувати різні вправи. Для одних вуличні спортивні тренажери – це чудова можливість заняття фізкультурою та формуванням сильного тіла, для інших – це спосіб зміцнити організм, а треті просто з користю проводять вільний час.

The popularization of healthy living at the national level is directed to attract different segments of the population to sports. This is one of the reasons for the appearance in cities and other settlements, an increasing number of sports playgrounds with outdoor sports equipment. With their help, everyone can do various exercises for free and at any convenient time right on the street. For some, outdoor fitness equipment is a great opportunity to exercise and build a strong body, while for others it is a way to strengthen the body, and for others it is a way to spend their free time with benefit.



SO-10.02



SO-10.03



SO-10.01

	A	♿	📏	📐	📐	👤	👤+	📊	📊	📊	HDPE	HPL
SO-10.01	-		1,26x0,5x1,25	17,6	< 0,6	12+	1	73	●	-	-	-
SO-10.02	-		2,17x0,5x1,25	21,7	< 0,6	12+	2	123	●	-	-	-
SO-10.03	-		1,27x1,3x2,3	17,8	1,7	12+	2	64	●	-	-	-



SO-10.04

SO-10.05

SO-10.06



SO-10.07

SO-10.08

	A	♿	📏	📐	📐	👤	👤+	📊	📊	📊	HDPE	HPL
SO-10.04	-		1,0x0,7x1,1	14,8	< 0,6	12+	1	38	●	-	-	-
SO-10.05	-		1,35x1,23x1,3	16,8	< 0,6	12+	3	67	●	-	-	-
SO-10.06	-		1,5x0,38x2,3	14,8	1,3	12+	1	94	●	-	-	-
SO-10.07	-		2,4x2,4x1,0	41	1	12+	1	95	●	-	-	-
SO-10.08	-		1,8x0,6x1,0	26,6	1	12+	2	75	●	-	-	-





SO-10.11

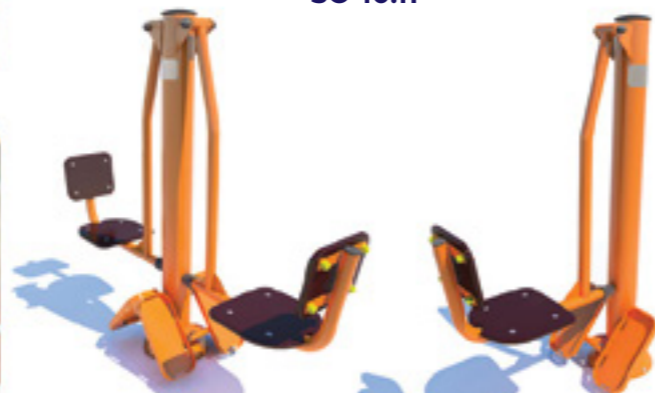

SO-10.10

SO-10.10.1



SO-10.12



SO-10.13



SO-10.15



SO-10.14



SO-10.16



SO-10.15.1



SO-10.14.1



SO-10.17

	A	♿	📐	📐	📐	👤	👤+	📊	■	■	🌀	HDPE	HPL
SO-10.10	-		1,7x0,47x1,5	16,2	< 0,6	12+	2	65	●	-	-	●	-
SO-10.10.1	-		1,0x0,47x1,5	15,8	< 0,6	12+	2	46	●	-	-	●	-
SO-10.11	-		1,4x0,75x1,2	25,6	1,2	12+	2	66	●	-	-	-	-
SO-10.12	-		1,6x0,57x1,09	16,4	< 0,6	12+	2	37	●	-	-	●	-
SO-10.13	-		1,23x0,58x1,7	15,4	< 0,6	12+	1	56,7	●	-	-	-	-

	A	♿	📐	📐	📐	👤	👤+	📊	■	■	🌀	HDPE	HPL
SO-10.14	-		1,7x1,0x1,96	19,3	< 0,6	12+	2	100	●	-	-	●	-
SO-10.14.1	-		1,56x1,0x1,96	18,2	< 0,6	12+	1	66	●	-	-	●	-
SO-10.15	-		1,85x0,85x1,96	19,5	< 0,6	12+	2	98	●	-	-	●	-
SO-10.15.1	-		1,08x0,88x1,96	15,8	< 0,6	12+	1	65	●	-	-	●	-
SO-10.16	-		1,56x1,0x1,96	19,1	< 0,6	12+	2	99	●	-	-	●	-
SO-10.17	-		1,1x0,75x0,78	15,4	< 0,6	12+	1	30	●	-	-	●	-





	A	♿	📏	📏	📏	👤	👤	🏋️	📏	📏	📏	HDPE	HPL
SO-10.18	-		1,1x0,75x1,28	15,4	1	12+	2	54	●	-	-	-	-
SO-10.18.1	-		1,23x0,74x1,28	15,5	1	12+	2	65	●	-	-	-	-
SO-10.19	-		1,46x0,83x0,72	17	< 0,6	12+	1	51	●	-	-	●	-
SO-10.20	-		1,8x0,4x2,85	26	1,5	12+	2	64	●	-	-	-	-
SO-10.21	-		1,64x0,68x1,55	17	1,2	12+	2	66	●	-	-	-	-
SO-10.22.1	-		1,37x1,32x0,6	20	< 0,6	12+	2	71	●	-	-	●	-







	A	♿	📏	📏	👤	👤+	🏋️	🔲	🔲	🌀	HDPE	HPL	
SO-10.23	-		1,39x0,7x1,57	16	<0,6	12+	2	55	●	●	-	●	-
SO-10.24	-		1,32x1,36x2,2	18,5	1,2	12+	1	58	●	●	-	●	-
SO-10.25	-		1,53x0,66x1,72	16,5	<0,6	12+	2	74	●	●	-	-	-
SO-10.30	-		0,9x0,5x1,6	13,6	<0,6	12+	1	42	●	●	-	-	-
SO-10.30.1	-		1,36x0,75x1,28	16	<0,6	12+	2	57	●	●	-	-	-
SO-10.31	-		1,23x1,0x1,96	17	<0,6	12+	1	86	●	●	-	●	-

	A	♿	📏	📏	👤	👤+	🏋️	🔲	🔲	🌀	HDPE	HPL	
SO-10.31.1	-		1,79x1,23x1,96	20,2	<0,6	12+	2	140	●	-	-	●	-
SO-10.32	-		0,78x0,65x1,3	21,8	<0,6	12+	1	31	●	-	-	●	-
SO-10.32.2	-		1,76x0,66x1,32	17,4	<0,6	12+	2	59	●	-	-	●	-
SO-10.33	-		1,63x0,53x1,06	16,3	<0,6	12+	2	60	●	-	-	●	-
SO-10.34	●		0,87x0,56x1,8	22,4	<0,6	12+	2	61	●	-	-	●	-
SO-10.35	●		1,51x1,2x1,5	19	<0,6	12+	2	86	●	-	-	●	-





SO-10.36

SO-10.37

SO-10.49



SO-10.38

SO-10.39

SO-10.40



SO-10.43

SO-10.45

SO-10.53



Model	Color	Dimensions (LxWxH)	Weight	Resistance	Age Group	Capacity	Weight	Material 1	Material 2	Material 3	Material 4	Material 5	Material 6	Material 7
SO-10.36	-	2,4x0,63x1,03	29,6	< 0,6	12+	2	56	●	-	-	●	-	-	-
SO-10.37	-	2,52x0,62x1,0		< 0,6	12+	2	56	●	-	-	●	-	-	-
SO-10.38	-	1,22x0,62x0,97	15,2	< 0,6	12+	1	53	●	-	-	●	-	-	-
SO-10.39	-	1,1x0,65x1,45	14,9	< 0,6	12+	2	79	●	-	-	-	-	-	-
SO-10.40	-	1,75x1,75x2,53	22,5	1,6	12+	4	101	●	-	-	-	-	-	-
SO-10.43	-	1,22x0,75x1,38	24	< 0,6	12+	2	73	●	-	-	-	-	-	-
SO-10.45	-	1,32x0,64x1,41	15,7	< 0,6	12+	2	70	●	-	-	●	-	-	-
SO-10.49	●	0,74x0,61x1,35	22	< 0,6	12+	2	40	●	-	-	-	-	-	-
SO-10.53	●	1,5x0,88x1,7	26,8	< 0,6	12+	2	64	●	-	-	●	-	-	-



SO-10.58

SO-10.64

SO-10.65



SO-10.66

SO-10.67

SO-10.68

SO-10.69



Model	Color	Dimensions (LxWxH)	Weight	Resistance	Age Group	Capacity	Weight	Material 1	Material 2	Material 3	Material 4	Material 5	Material 6	Material 7
SO-10.58	●	1,5x0,88x1,7	17,4	< 0,6	12+	2	65	●	-	-	●	-	-	-
SO-10.64	-	1,47x1,11x0,79	18,3	< 0,6	12+	2	99	●	-	-	●	-	-	-
SO-10.65	-	0,97x0,45x1,28	13,7	< 0,6	12+	2	46	●	-	-	-	-	-	-
SO-10.66	-	1,69x1,11x2,4	19,2	< 0,6	12+	2	102	●	-	-	-	-	-	-
SO-10.67	●	1,2x1,16x1,21	17,4	< 0,6	12+	2	61	●	-	-	●	-	-	-
SO-10.68	-	1,43x1,42x0,9	19,5	< 0,6	12+	2	67	●	-	-	●	-	-	-
SO-10.69	-	1,08x0,74x1,21	15,2	< 0,6	12+	2	69	●	-	-	-	-	-	-



## Серія Street Workout / Street Workout

Workout тренажери це обладнання для людей, які зацікавлені у покращенні свого здоров'я. Встановлюються для занять на свіжому повітрі. Дозволяють підтримувати фізичну форму. Тренажери для Workout, випробувані на міцність та безпеку. Допоможуть стати володарем спортивної фігури, гарного самопочуття та настрою.

Workout equipment is designed for people who are interested in improving their health. They are installed for outdoor training. They allow you to keep yourself in good physical shape. Workout equipment is tested for durability and safety. They will help you to become the owner of a sporty figure, good health and mood.



SW-11.01



SW-11.02



SW-11.03

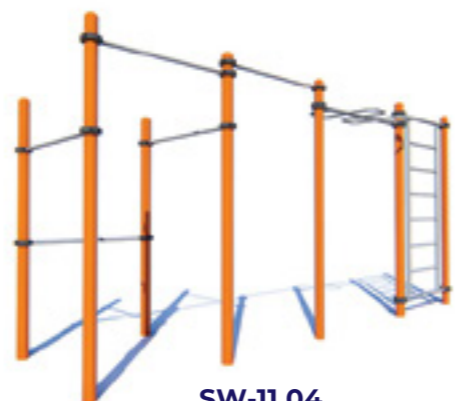

SW-11.04



Model	Dimensions (LxWxH)	Weight	Height	Age Group	Capacity	Weight Capacity	Material 1	Material 2	Material 3	Material 4
SW-11.01	4,39x0,16x1,5	34,9	1,5	8+	3	94	●	-	-	-
SW-11.02	5,24x1,55x2,8	51,3	2,8	8+	2	341	●	-	-	-
SW-11.03	8,06x1,55x3,0	66,9	3	8+	6	572	●	-	-	-
SW-11.04	6,2x1,84x2,9	59,5	2,9	8+	6	352	●	-	-	-









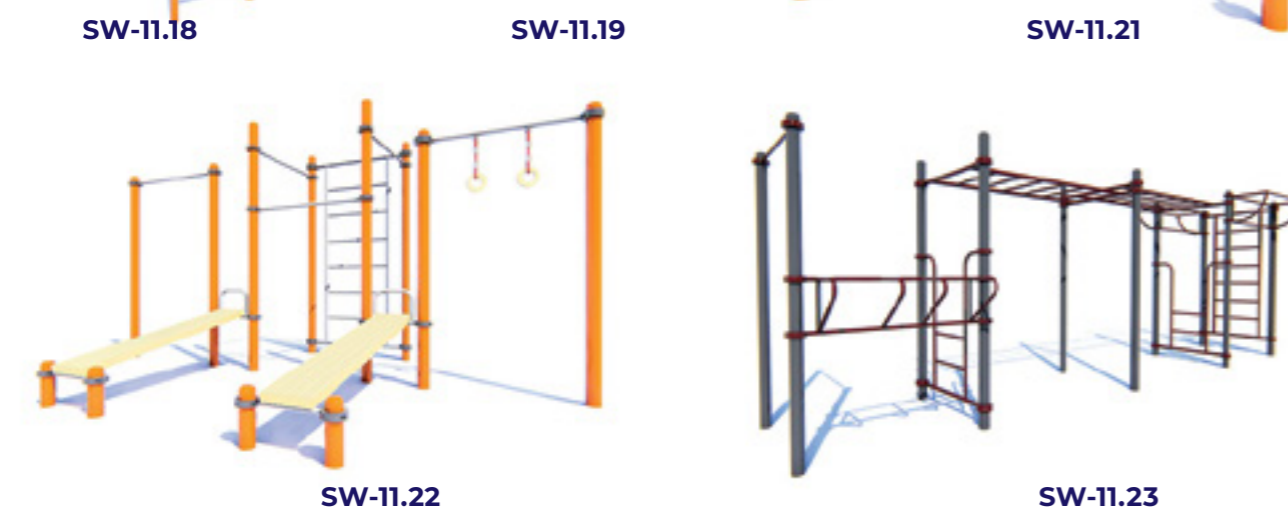

	A	♿	📏	📐	📐	👤	👤	📊	📊	📊	HDPE	HPL
SW-11.18	-		2,5x1,14x1,6	33,4	1,6	8+	2	79	●	-	-	-
SW-11.19	-		3,56x2,1x2,6	46,1	1,6	8+	3	198	●	-	●	-
SW-11.21	-		2,96x3,5x3,0	52,2	3	8+	5	328	●	-	●	-
SW-11.22	-		5,56x3,5x3,0	71,7	3	8+	6	514	●	-	●	-
SW-11.23	-		8,86x2,54x3,0	84,1	3	8+	6	708	●	-	-	-

	A	♿	📏	📐	📐	👤	👤	📊	📊	📊	HDPE	HPL
SW-11.20	-		0,8x0,1x2,0	19,6	2	8+	1	46	●	-	-	-
SW-11.24	-		4,0x1,56x3,0	44,4	3	8+	4	344	●	-	-	-
SW-11.27	-		8,67x6,8x4,0	136,8	3	8+	8	624	●	-	●	-
SW-11.30	-		3,19x3,2x3,0	51,7	3	8+	4	320	●	-	●	-
SW-11.33	-		4,0x2,6x2,7	52,8	2,5	8+	4	346	●	-	●	-



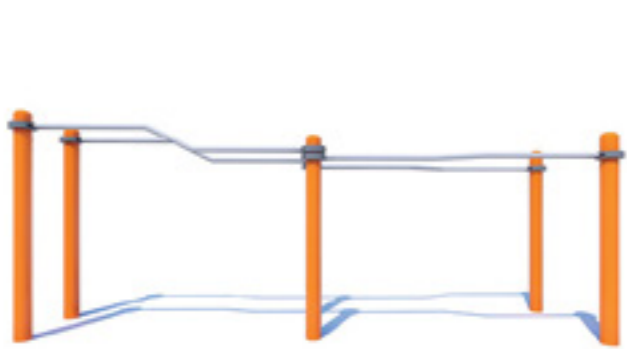

IN - 12.08



IN - 12.09



IN - 12.10



IN - 12.11



IN - 12.12

	A	♿	📏	📐	📐	👤	👤+	🏋️	🔲	🔳	🌳	HDPE	HPL
IN - 12.08	●		4,0x1,06x1,5	40	1,5	7-14	2	126	●	-	-	-	-
IN - 12.09	●		6,0x4,0x2,6	80	2,6	7-14	6	433	●	-	●	-	-
IN - 12.10	●		1,96x0,7x1,1	28	1,1	7-14	1	88	●	-	-	-	-
IN - 12.11	●		1,93x1,4x2,6	32	1,6	7-14	1	118	●	-	-	-	-
IN - 12.12	●		1,1x0,4x2,0	22	<0,6	7-14	1	48	●	-	-	-	-

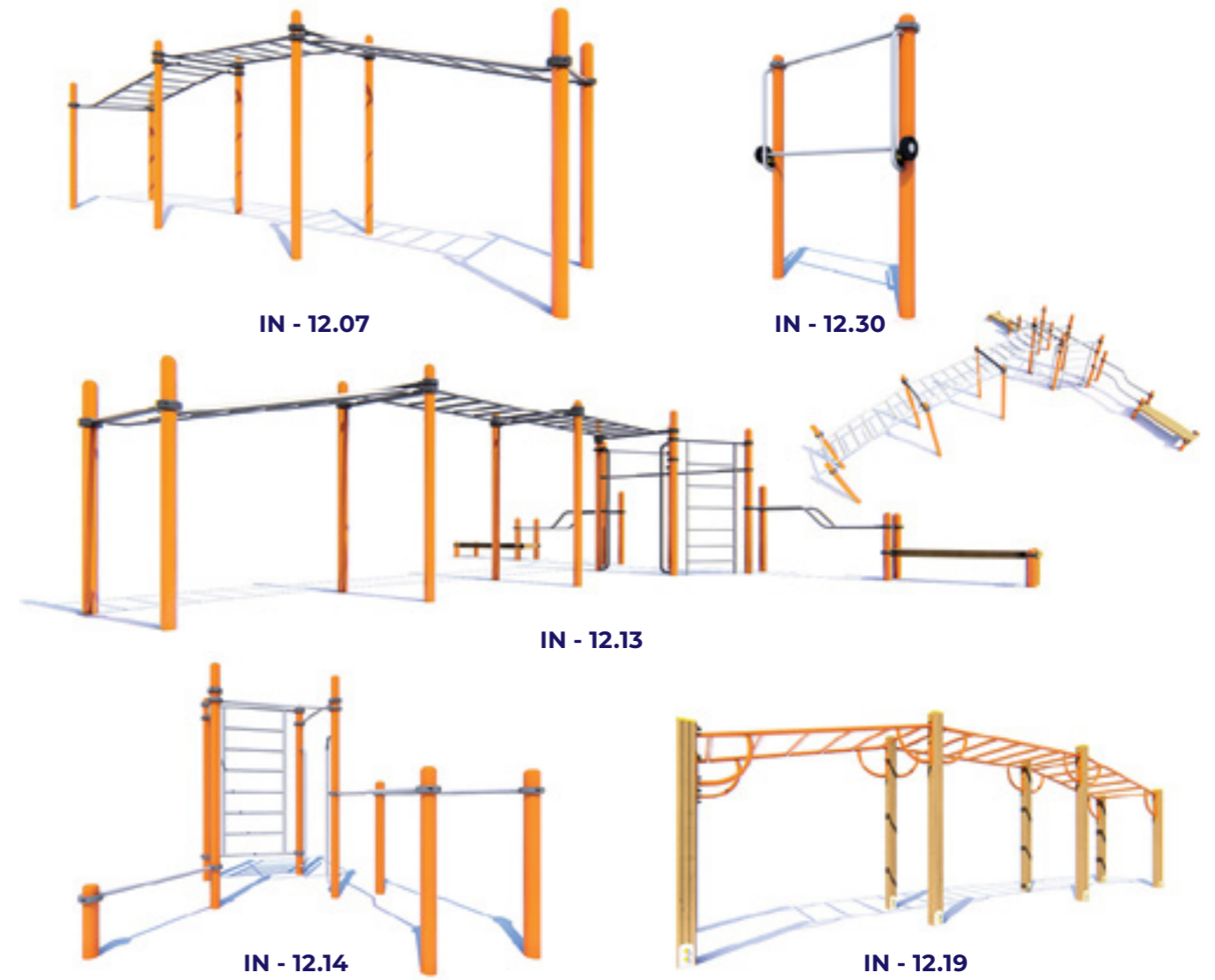

IN - 12.07

IN - 12.30

IN - 12.13

IN - 12.14

IN - 12.19

	A	♿	📏	📐	📐	👤	👤+	🏋️	🔲	🔳	🌳	HDPE	HPL
IN - 12.07	●		7,8x1,76x2,4	68	1,4	7-14	2	427	●	-	-	-	-
IN - 12.13	●		10,7x9,6x2,6	200	2,6	7-14	8	860	●	-	●	-	-
IN - 12.14	●		3,3x2,85x2,6	50	2,6	7-14	6	280	●	-	-	-	-
IN - 12.19	●		6,4x1,0x2,0	52	2	7-14	2	220	●	-	●	-	-
IN - 12.30	●		1,5x0,26x2,2	20	1	7-14	1	80	●	-	-	-	-

ХАРАКТЕРИСТИКИ РОЗДІЛУ «СПОРТИВНЕ ОБЛАДНАННЯ» / CHARACTERISTICS OF «SPORTS EQUIPMENT» SECTION

- Конструкція містить оцинковану чи пофарбовану сталь  
 The structure contains galvanized or painted steel
- Дерев'яна конструкція  
 Wood construction
- Захисний верх  
 Protective tops
- Рухомі елементи  
 Movable elements
- Конструкції:
  - Пофарбована сталь
  - Нерж. сталь
  - Пофарбоване дерево
- Анкерування:
  - Поверхневе
  - Глибоке
 Anchoring:
  - Surface
  - Deep

\* Варіанти матеріалів стосуються вибраних продуктів, для отримання додаткової інформації відвідайте [www.goida-da.com](http://www.goida-da.com)

\* Material options apply to selected products, for more information visit [www.goida-da.com](http://www.goida-da.com)



## Урни, лавки, дивани, столи, садові комплекти/ Urns, benches, sofas, tables, garden sets

Урни є гарним доповненням при облаштуванні дитячого, спортивного майданчика, а також при облаштуванні парку чи скверу. Ці урни виконані з металевого листа і труби. Пофарбовані порошковою фарбою. Перед фарбуванням всі металеві вироби проходять дробоструминне очищення.

The urns are a good addition to the arrangement of a children's or sports playground, as well as to the arrangement of a park or square. These urns are made of metal sheet and pipe. They are painted with powder paint. Before painting, all metal products are shot blasted.



UM-1.12



UM-1.13



UM-1.14



UM-1.03



UM-1.04



UM-1.06



UM-1.03	0,45x0,45x0,7	23	●	-	●	○	-
UM-1.04	0,37x0,37x0,9	63	●	-	●	-	-
UM-1.06	0,36x0,25x0,97	33	●	-	●	-	-
UM-1.12	0,46x0,46x0,8	40	●	-	●	○	-
UM-1.13	0,46x0,46x1,0	49	●	-	●	○	-
UM-1.14	1,18x0,46x1,0	112	●	-	●	○	-





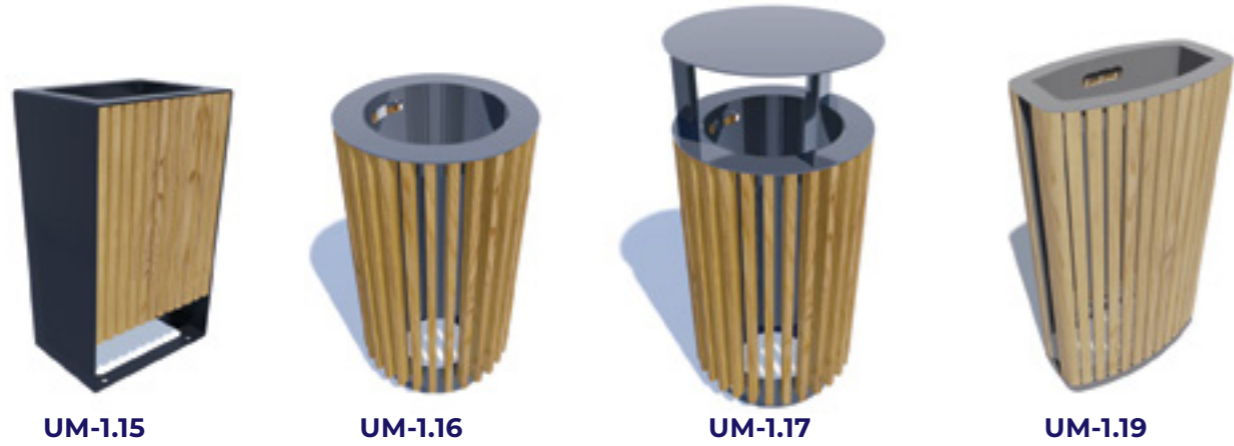

UM-1.15

UM-1.16

UM-1.17

UM-1.19



UM-1.20



Model	Dimensions (mm)	Weight (kg)	A	m	kg	square	triangle	wood	HDPE	HPL
UM-1.15	0,48x0,38x0,82	55	●	-	-	●	○	-	-	-
UM-1.16	0,44x0,44x0,8	32	●	-	-	●	○	-	-	-
UM-1.17	0,44x0,44x1,0	38	●	-	-	●	○	-	-	-
UM-1.19	0,48x0,27x0,86	25	●	-	-	●	○	-	-	-
UM-1.20	0,5x0,27x1,06	30	●	-	-	●	○	-	-	-



UM-1.18

UM-1.21

UM-1.22

UM-1.23

UM-1.25

UM-1.26

UM-1.27

UM-1.28

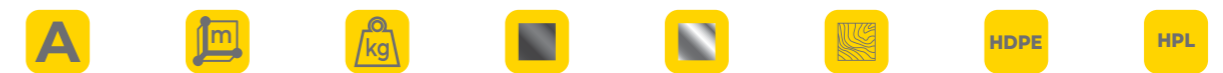

Model	Dimensions (mm)	Weight (kg)	A	m	kg	square	triangle	wood	HDPE	HPL
UM-1.18	1,2x0,44x1,0	101	●	-	-	●	○	-	-	-
UM-1.21	0,48x0,27x0,87	31	●	-	-	●	○	-	-	-
UM-1.22	0,5x0,27x1,1	37	●	-	-	●	○	-	-	-
UM-1.23	0,48x0,27x0,86	25	●	-	-	●	○	-	-	-
UM-1.25	0,48x0,27x0,87	25	●	-	-	●	○	-	-	-
UM-1.26	0,5x0,27x1,1	29	●	-	-	●	○	-	-	-
UM-1.27	0,48x0,27x0,87	25	●	-	-	●	○	-	-	-
UM-1.28	0,5x0,27x1,1	31	●	-	-	●	○	-	-	-





UM-1.24

UM-1.29

UM-1.30

UM-1.31

DM-2.04

DM-2.06



UM-1.01

UM-1.02

UM-1.05

UM-1.32

DM-2.10

DM-2.07



Model	Dimensions	Weight	Material 1	Material 2	Material 3	Material 4	Material 5	Material 6	Material 7
UM-1.01	0,4x0,3x0,9	11	•	-	-	-	-	-	-
UM-1.02	0,4x0,4x0,6	14	•	-	-	-	-	-	-
UM-1.05	0,39x0,32x0,97	11,5	•	-	-	-	-	-	-
UM-1.24	0,5x0,27x1,06	30	•	-	•	o	-	-	-
UM-1.29	0,58x0,56x0,82	39	•	-	•	o	-	-	-
UM-1.30	0,58x0,56x0,82	40	•	-	•	o	-	-	-
UM-1.31	0,58x0,56x0,82	38	•	-	•	o	-	-	-
UM-1.32	0,42x0,2x1,0	34	•	-	-	-	-	-	-



Model	Dimensions	Weight	Material 1	Material 2	Material 3	Material 4	Material 5	Material 6	Material 7	Material 8	Material 9
DM-2.04	1,7x0,8x0,8	0,8	3	64	•	-	•	-	-	-	-
DM-2.06	1,7x0,4x0,78	0,8	3	29	•	-	•	-	-	-	-
DM-2.07	1,5x0,8x0,8	0,8	3	62	•	-	•	-	-	-	-
DM-2.10	2,3x0,82x1,1	0,8	4	46	•	-	•	-	-	-	-





DM-2.08



SM-2.02



SM-2.03



SM-2.09



DM-2.11



SK-2.01



	A	m	m	+	kg				HDPE	HPL
DM-2.08	2,0x0,49x0,86	0,86	4	46	•	-	•	-	-	-
DM-2.11	2,0x1,3x1,75	1	4	160	•	-	•	-	-	-

	A	m	m	+	kg				HDPE	HPL
SM-2.02	2,0x0,48x0,43	<0,6	4	31	•	-	•	-	-	-
SM-2.03	1,65x0,4x0,45	<0,6	3	15	•	-	•	-	-	-
SM-2.09	0,60x0,45x0,45	<0,6	1	26	•	-	•	-	-	-
SK-2.01	1,55x1,55x0,8	0,8	3	63	•	-	•	-	-	-





SM-2.13



SM-2.14



SM-2.15



	A	m	m	+	kg			HDPE	HPL
SM-2.13	1,9x0,4x0,57	<0,6	4	30	●	-	●	○	-
SM-2.14	1,86x0,58x0,5	<0,6	4	53	●	-	●	○	-
SM-2.15	2,6x1,0x0,44	<0,6	6	98	●	-	●	○	-



SM-2.15-03



SM-2.24



SM-2.26



SM-2.27



SM-2.28



SM-2.29



SM-2.30



	A	m	m	+	kg			HDPE	HPL
SM-2.15-03	2,6x1,08x0,86	0,86	6	103	●	-	●	○	-
SM-2.24	1,7x0,64x0,79	0,8	3	54	●	-	●	○	-
SM-2.26	0,51x0,44x0,45	<0,6	1	23	●	-	●	○	-
SM-2.27	1,81x0,44x0,45	<0,6	3	40	●	-	●	○	-
SM-2.28	1,81x0,44x0,59	<0,6	3	44	●	-	●	○	-
SM-2.29	1,81x0,46x0,88	0,9	3	62	●	-	●	○	-
SM-2.30	1,81x0,46x0,89	0,9	3	64	●	-	●	○	-



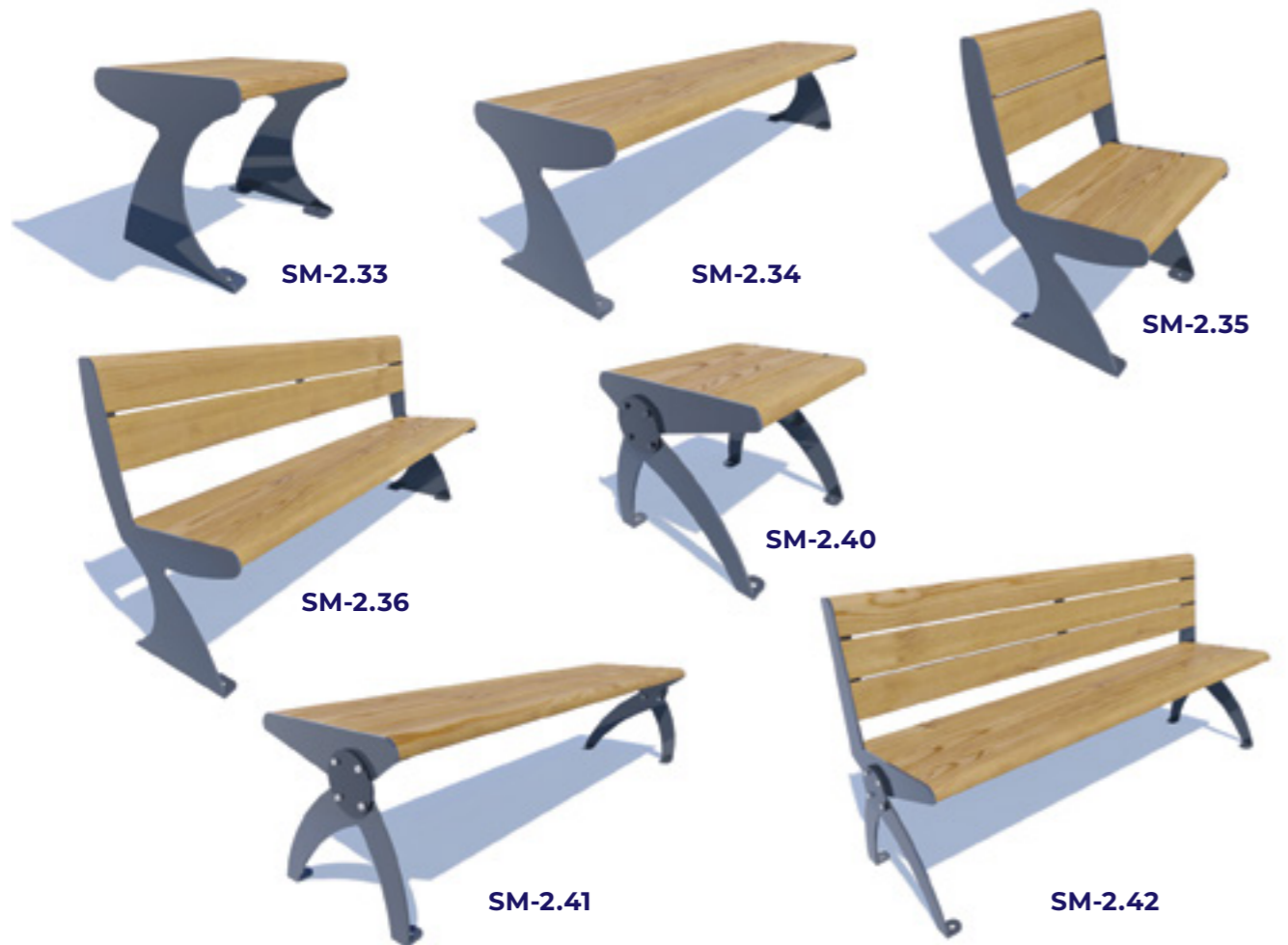

	A	m	m	+	kg				HDPE	HPL
SM-2.33	0,51x0,44x0,45	<0,6	1	23	•	-	•	o	-	-
SM-2.34	1,81x0,44x0,45	<0,6	3	40	•	-	•	o	-	-
SM-2.35	0,51x0,5x0,83	0,83	1	33	•	-	•	o	-	-
SM-2.36	1,81x0,5x0,83	0,83	3	61	•	-	•	o	-	-
SM-2.40	0,54x0,47x0,45	<0,6	1	24	•	-	•	o	-	-
SM-2.41	1,84x0,47x0,45	<0,6	3	42	•	-	•	o	-	-
SM-2.42	1,84x0,51x0,86	0,86	3	66	•	-	•	o	-	-

	A	m	m	+	kg				HDPE	HPL
SM-2.43	1,8x0,6x0,88	0,86	3	70	•	-	•	o	-	-
SM-2.44	0,62x0,6x0,88	0,88	1	39	•	-	•	o	-	-
SM-2.45	1,77x0,44x0,45	<0,6	3	57	•	-	•	o	-	-
SM-2.46	1,77x0,44x0,45	<0,6	3	63	•	-	•	o	-	-
SM-2.47	1,8x0,56x0,9	0,9	3	73	•	-	•	o	-	-
SM-2.49	2,33x0,6x0,7	<0,7	2	84	•	-	•	o	-	-



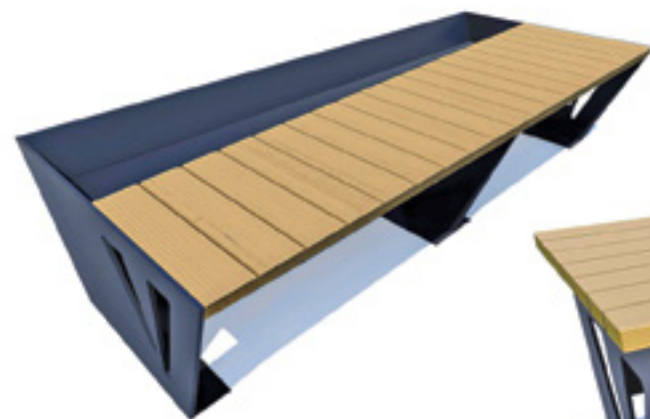

SM-2.11



SM-2.12



SK-2.05



SK-2.07

	A	m	m	+	kg				HDPE	HPL
SM-2.11	2,0x0,85x0,45	<0,6	4	165	•	-	•	o	-	-
SM-2.12	2,0x0,75x0,8		8	129	•	-	•	o	-	-

	A	m	m	+	kg				HDPE	HPL
SK-2.05	2,2x2,16x2,15	0,8	6	223	•	-	•	o	-	-
SK-2.07	2,1x1,8x0,75	0,75	6	140	•	-	•	o	-	-



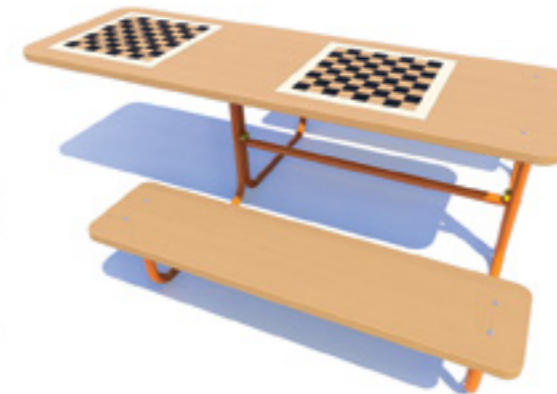

SK-2.11

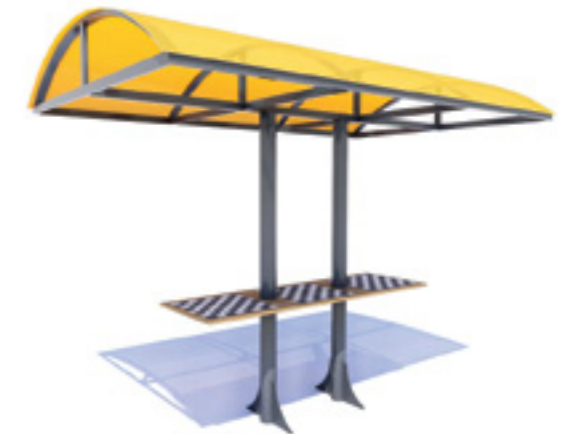

SK-2.13

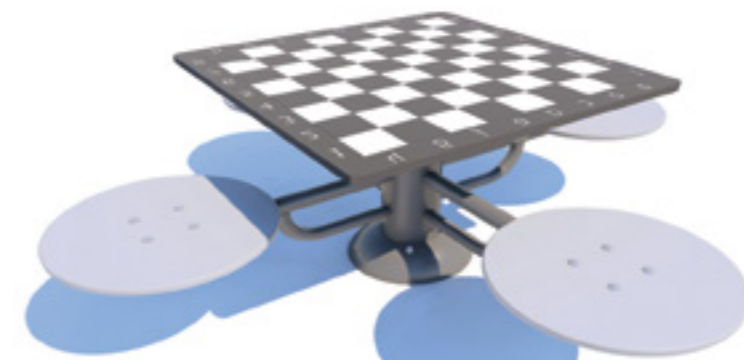

SK-2.12



SK-2.11	2,3x1,85x0,8	0,8	4	99	●	-	●	○	-
SK-2.12	2,0x2,0x0,9	0,9	4	33	●	-	●	○	-
SK-2.13	3,05x1,94x2,45	0,9	6	50	●	-	●	○	-



# Облаштування дитячих майданчиків / Children's playground equipment



Облаштування території – важливе питання під час створення комфортних умов для відпочинку. Паркові огорожі є незамінним елементом в оформленні дитячих майданчиків, дитсадків, дворів.

Arrangement of the territory is an important issue when creating comfortable conditions for recreation. Park fences are an indispensable element in the design of playgrounds, kindergartens, and yards.



OD-4.03



OD-4.04



OD-4.06



OD-4.11.1

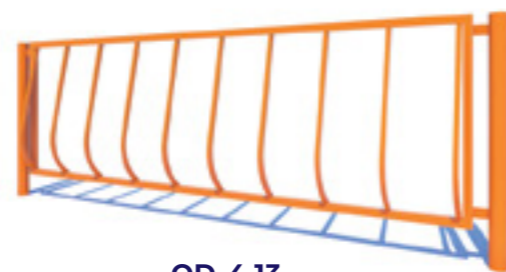

OD-4.13



OD-4.08



OD-4.09



OD-4.09.1



OD-4.16



OD-4.10



OD-4.28



Model	Dimensions	Height	Weight	Material	Color	Material	Material	Material	Material
OD-4.03	2,0x0,05x1,1	1,1	34	•	-	-	-	-	-
OD-4.04	2,0x0,33x1,1	1,1	53	•	-	-	-	-	-
OD-4.06	1,5x0,04x0,6	<0,6	14	•	-	-	-	-	-
OD-4.11.1	2,0x0,0,4x0,7	0,6	7	•	-	-	-	-	-
OD-4.13	2,0x0,12x0,7	0,6	20	•	-	-	-	-	-

OD-4.08	2,6x0,15x3,5	-	-	140	•	-	-	-	-
OD-4.09	2,2x0,2x3,1	-	-	95	•	-	-	-	-
OD-4.09.1	2,2x0,75x2,9	-	-	67	•	-	-	-	-
OD-4.10	2,1x0,15x2,8	-	-	68	•	-	-	-	-
OD-4.16	2,0x0,05x1,2	1,15	-	35	•	-	-	-	-
OD-4.28	2,88x0,1x2,6	-	-	134	•	-	-	-	-





Каніювана сітка/  
Cannulated mesh

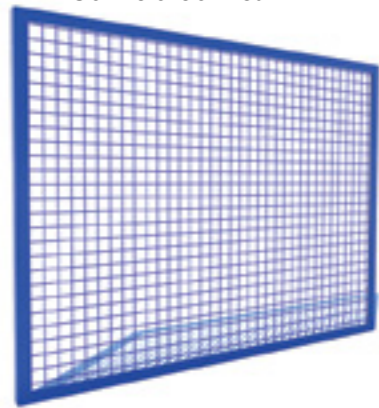

OD-4.12



OD-4.31



CD-4.08

Оцинкована рабиця/  
Galvanized chain

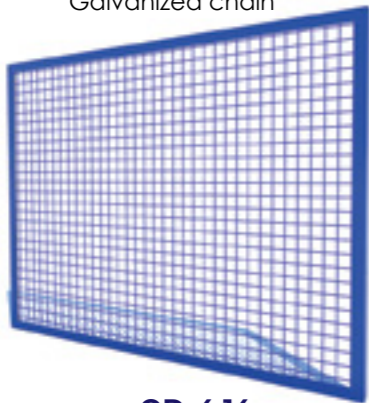

OD-4.14

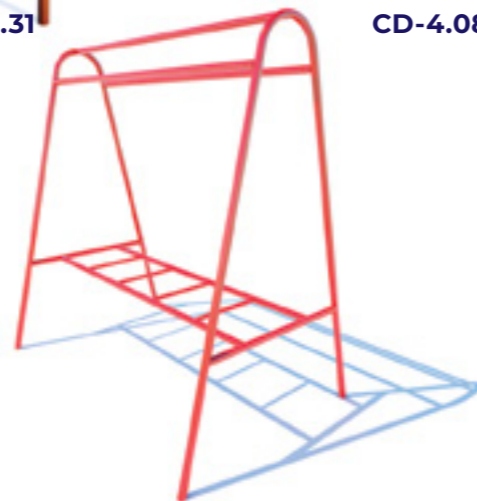

DO-4.01



	A	m	kg	■	▲	▨	HDPE	HPL
OD-4.12	2,0x0,05x1,5	27	●	-	●	-	-	-
OD-4.14	2,0x0,05x1,5	27	●	-	●	-	-	-
OD-4.31	0,64x0,04x1,63	22	●	-	●	-	-	-
DO-4.01	2,5x1,5x2,2	85	●	-	●	-	-	-
CD-4.08	0,7x0,05x0,4	4	●	-	●	-	-	-



SV-4.15



SV-4.16

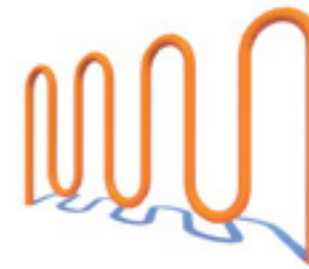

SV-4.17



SV-4.18



SV-4.19

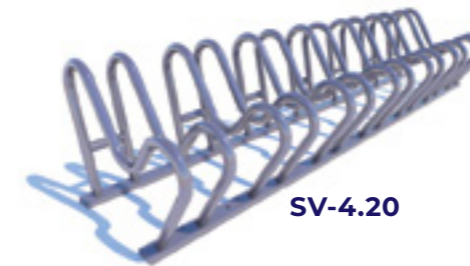

SV-4.20



SV-4.21



	A	m	kg	■	▲	▨	HDPE	HPL
SV-4.15	3,0x0,6x0,5	39	●	○	●	-	-	-
SV-4.16	3,0x0,6x0,6	58	●	○	●	-	-	-
SV-4.17	2,2x0,04x1,0	13	●	○	●	-	-	-
SV-4.18	1,4x1,21x0,96	46	●	○	●	-	-	-
SV-4.19	1,3x0,7x0,75	38	●	○	●	-	-	-
SV-4.20	2,0x0,5x0,4	38	●	○	●	-	-	-
SV-4.21	1,95x4,1x0,8	90	●	○	●	-	-	-





	A						HDPE	HPL
LS-15.02	1,1x0,15x10,0	220	●	-	●	-	-	-
LS-16.01	1,2x0,15x5,5	181	●	-	●	-	-	-
LS-16.02	1,55x0,7x5,55	200	●	-	●	-	-	-

## Покриття/Coating

Гумова плитка від ТМ «Гойда» – служить як підлогове покриття, але може використовуватися на будь-яких поверхнях. Завдяки помірній щільності, підійде як для комерційних приміщень (спортивні зали), так і для вуличного простору (дворові майданчики, відкриті тераси). Практикується використання на дитячих ігрових майданчиках, стадіонах, доріжках для бігу та пішої ходьби. Додаткові властивості входять зносостійкість, високий рівень допустимих навантажень, стійкість до деформації та опір ковзанню.

Rubber tile from TM «Goida» - serves as a floor covering, but can be used on any surfaces. Due to its moderate density, it is suitable for both commercial premises (sports halls) and outdoor spaces (courtyards, open terraces). It is used in children's playgrounds, stadiums, jogging and walking paths. Additional properties include wear resistance, high level of permissible loads, resistance to deformation and slip resistance.



	A						EPDM SBR	HPL
KR-3.01	0,5x0,5x0,02	17,2	-	-	-	●	-	
KR-3.02	0,5x0,5x0,025	21	-	-	-	●	-	
KR-3.03	0,5x0,5x0,03	24,2	-	-	-	●	-	
KR-3.04	0,5x0,5x0,035	26	-	-	-	●	-	
KR-3.05	0,5x0,5x0,04	28,7	-	-	-	●	-	
KR-3.06	0,5x0,5x0,05	33,4	-	-	-	●	-	

### ХАРАКТЕРИСТИКИ РОЗДІЛУ «ОБЛАДНАННЯ ДЛЯ ПАРКУ»/ CHARACTERISTICS OF «PARK EQUIPMENT» SECTION

Конструкція, елементи з оцинкованої або пофарбованої сталі Construction, elements from galvanized or painted steel	Дерев'яна конструкція Wood construction	Оцинковані анкери Galvanized anchors	Анкерування: - Поверхневе - Глибоке Anchoring: - Surface - Deep
---	--	---	--

\* Варіанти матеріалів стосуються вибраних продуктів, для отримання додаткової інформації відвідайте [www.goida-da.com](http://www.goida-da.com)

\* Material options apply to selected products, for more information visit [www.goida-da.com](http://www.goida-da.com)







## Облаштування зон вихулу собак / Arrangement of dog walking areas

Обладнання призначене для вихулу та дресирування собак. Обладнання буде чудовим місцем для активного відпочинку Ваших домашніх улюбленців.

The equipment is designed for walking and training dogs. The equipment will be a great place for active recreation of your pets.



PS-11.02



PS-11.01



PS-11.03

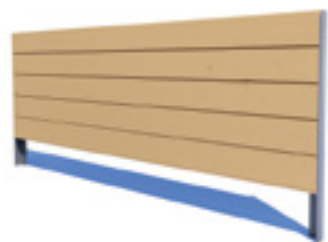

PS-11.04

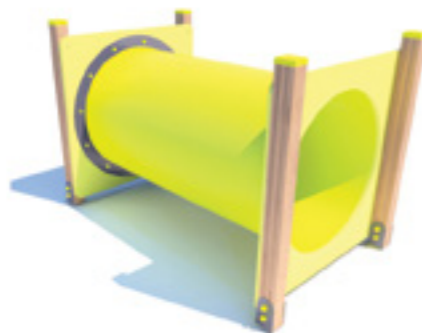

PS-11.19



PS-11.06



	5,1x1,1x3,2	37	320	●	●	-	-
PS-11.01	5,1x1,1x3,2	37	320	●	●	-	-
PS-11.02	1,5x0,05x1,8	22	95	●	●	-	-
PS-11.03	1,5x0,05x1,0	22	50	●	●	-	-
PS-11.04	1,5x0,05x0,5	22	30	●	●	-	-
PS-11.06	4,0x0,8x0,4	48	45	●	-	-	-
PS-11.19	1,6x1,0x1,3	28	100	●	●	-	-







PS-11.07



PS-11.08



PS-11.11



PS-11.12



PS-11.13



PS-11.09



PS-11.10



PS-11.17



	A	m	m <sup>2</sup>	kg	■	■	HDPE	HPL
PS-11.07	4,8x0,3x0,9	38	135	●	●	-	-	
PS-11.08	5,8x0,3x0,9	42	93	●	●	-	-	
PS-11.09	5,3x0,9x1,7	45	191	●	●	-	-	
PS-11.10	10,2x0,4x1,25	62	219	●	●	-	-	

	A	m	m <sup>2</sup>	kg	■	■	HDPE	HPL
PS-11.11	1,5x0,17x1,6	58	60	●	●	-	-	
PS-11.12	2,45x0,2x1,2	27	66	●	●	-	-	
PS-11.13	8,1x7,0x2,5	-	73,5	●	●	-	-	
PS-11.17	3,86x0,1x0,5	-	61	●	●	-	-	





PS-11.20



PS-11.21



PS-11.22



PS-11.20	2,0x0,7x1,3	28	85	•	•	-	-
PS-11.21	2,0x0,8x2,0	29	140	•	•	-	-
PS-11.22	9,45x1,5x1,0	74	473	•	•	-	-



PS-11.23

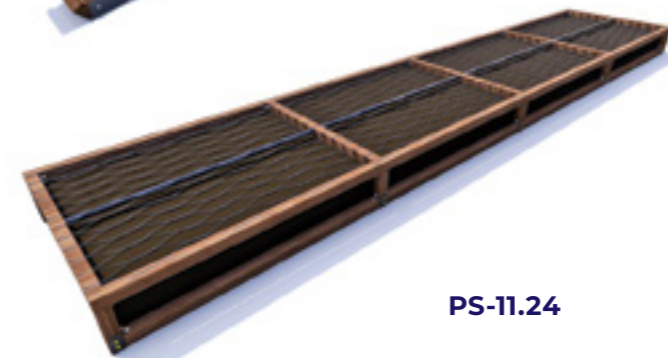

PS-11.24



PS-11.25



PS-11.23	11,3x0,8x1,2	74	256	•	•	-	-
PS-11.24	10,0x2,0x0,5	84	400	•	•	-	-
PS-11.25	7,9x1,2x5,04	62	840	•	•	-	-



# Проект «Здорова Україна» / «Healthy Ukraine» project

Представляємо вашій увазі цілий майданчик, укомплектований різноманітними спортивними тренажерами та призначений для встановлення в парках, на території навчальних закладів та у дворах житлових комплексів з відкритим доступом для всіх охочих. Велика перевага наших майданчиків у тому, що в кожного, хто тренуватиметься, з'явиться безкоштовний віртуальний тренер. Просканувавши QR-код на спеціальних стендах за допомогою мобільного пристрою, можна в режимі онлайн обрати рівень складності.

We present to your attention a whole playground equipped with a variety of sports equipment and designed to be installed in parks, on the territory of educational institutions and in the courtyards of residential complexes with open access for everyone. The big advantage of our playgrounds is that everyone who trains will have a free virtual coach. By scanning a QR code at special stands using a mobile device, you can choose the level of difficulty online.



**ЗДОРОВА УКРАЇНА**  
ПРОГРАМА ПРЕЗИДЕНТА УКРАЇНИ

Тренувальний майданчик збудовано у рамках програми Президента «Здорова Україна»

<b>ФІТНЕС</b>	<b>ВІТРІВАЛІСТЬ</b>
<b>ТОНУС М'ЯЗІВ</b>	<b>СИЛА</b>
<b>КООРДИНАЦІЯ</b>	<b>ГНУЧКІСТЬ</b>

**ЗДОРОВА УКРАЇНА**  
ПРОГРАМА ПРЕЗИДЕНТА УКРАЇНИ

Тренувальний майданчик збудовано у рамках програми Президента «Здорова Україна»

Програма створена з метою розширення доступності спортивних тренувань, покращення якості та тривалості життя населення.

Програма передбачає використання QR-кодів на спеціальних стендах, за допомогою яких можна безкоштовно обрати рівень складності тренування відповідно до своїх особливостей.

1. крок: **ВИБРАТИ РІВЕНЬ СКЛАДНОСТІ ТРЕНУВАННЯ ЗА М'ЯЗІВ**
2. крок: **ВИВІДИТИ РІВЕНЬ СКЛАДНОСТІ**
3. крок: **ВИВІДИТИ КОМПЛЕКС ВІДПОВІДНИХ ВІДПОВІДАЛЬНИХ ВІДПОВІДАЛЬНИХ ВІДПОВІДАЛЬНИХ**

**УВАГА!**

Тренувальні комплекси «Здорова Україна» не відсутні варті пропонування до фізичних навантажень. За необхідності попередньо проконсультуйтеся з лікарем.

**ЗДОРОВА УКРАЇНА**  
ПРОГРАМА ПРЕЗИДЕНТА УКРАЇНИ

**HEALTHY UKRAINE**  
PROGRAM OF THE PRESIDENT OF UKRAINE



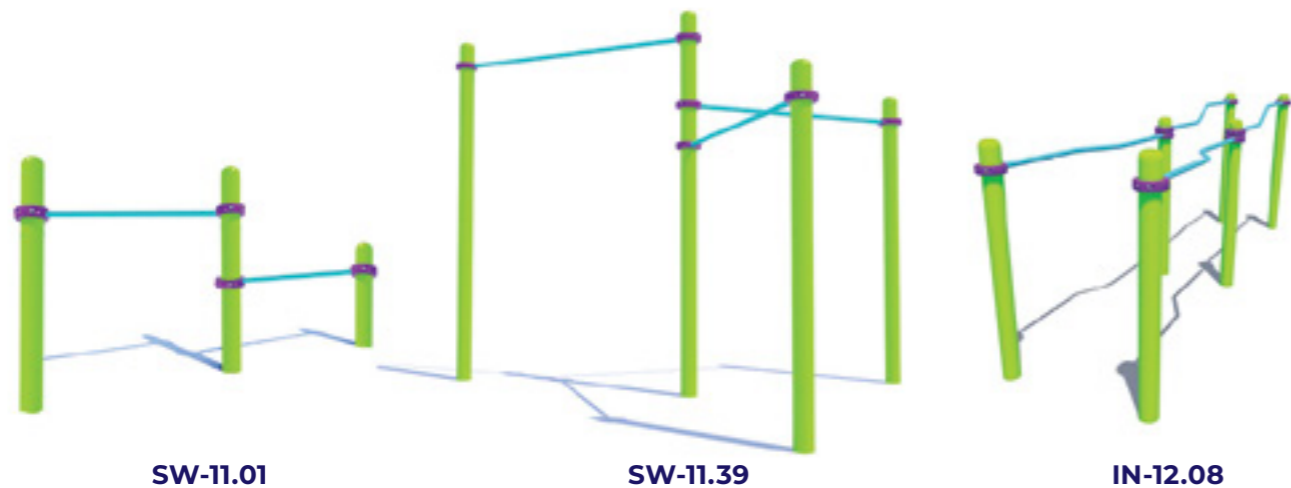

	A	♿	📐	📐	📐	👤	👤	📊	🔲	🔲	🔲	HDPE	HPL
SW-11.01	-					8+	3	94	●	-	-	-	-
SW-11.39	-					8+	1	129	●	-	-	-	-
SW-11.40.1	-					8+	1	16,2	●	-	-	-	-
SW-11.40.2	-					8+	1	18,4	●	-	-	-	-
IN - 12.07	●					7-14	2	325	●	-	-	-	-
IN - 12.08	●					7-14	2	126	●	-	-	-	-

	A	♿	📐	📐	📐	👤	👤	📊	🔲	🔲	🔲	HDPE	RUBBER EPDM
SW-11.41	-					8+	1	349	●	-	-	-	-
SW-11.42.30	-					8+	1	21	●	-	●	-	-
SW-11.42.45	-					8+	1	23	●	-	●	-	-
SW-11.42.60	-					8+	1	24,6	●	-	●	-	-
SW-11.15.4	-					8+	1	92	●	-	●	-	-
SW-11.15.5	-					8+	1	89	●	-	●	-	-
TRX-0.0	-					8+	1	1,33x2	●	●	-	-	●
TRX-1.3	-					8+	1	3,0x2	●	●	-	-	●
TRX-0.9	-					8+	1	3,3x2	●	●	-	-	●
TRX-0.4	-					8+	1	3,7x2	●	●	-	-	●





SM-2.13



UM-1.05



OD-4.31

Розмітка спортивного майданчика/  
Marking of the sports ground

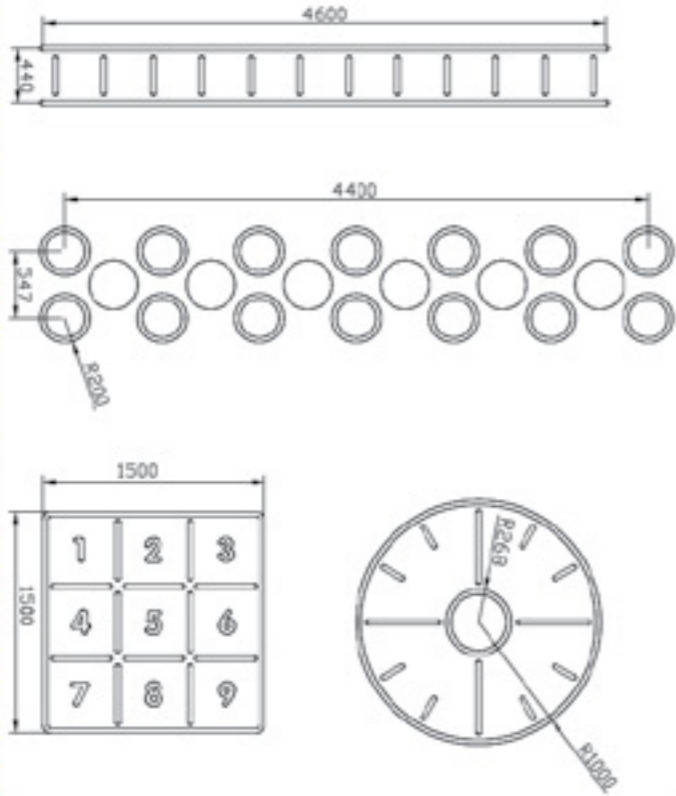

SM-2.13	-	1,9x0,4x0,57	29	<0,6	8+	4	30	●	-	●	-	-
UM-1.05	-	0,39x0,32x0,97	-	-	-	-	11,5	●	-	-	-	-
OD-4.31	-	0,64x0,04x1,63	-	-	-	-	22	●	-	○	-	-



## Дитячий майданчик перед Адміністрацією Президента/ Playground in front of the Presidential Administration

Ми дуже раді, що у нас вийшло реалізувати цей проект. Роботи Марії Примаченко були вибрані не випадково – вони якнайкраще ілюструють добро, українську гостинність і передають національний колорит.

We are very pleased that we have managed to implement this project. The artworks by Maria Prymachenko were not chosen by chance – they are the best illustrate kindness, Ukrainian hospitality and convey the national charm.









## Перший в Україні Інклюзивний парк / The first inclusive park in Ukraine

Інклюзивний парк має бути життєрадісним та яскравим. Він розташований у місті Дніпро, поблизу Обласної Адміністрації у 2018 році. Це впорядкована пішохідна зона, де переважає безбар'єрне середовище. Кожен дитячий майданчик від ТМ ГОЙДА – це результат наших високих стандартів якості, довговічності та безпеки, а також бездоганного дизайну.

An inclusive park should be cheerful and bright. It is located in the city Dnipro, near the Regional Administration in 2018. It is a well-maintained pedestrian zone with a barrier-free environment. Each playground by TH GOIDA is the result of our high standards of quality, durability and safety, as well as perfect design.

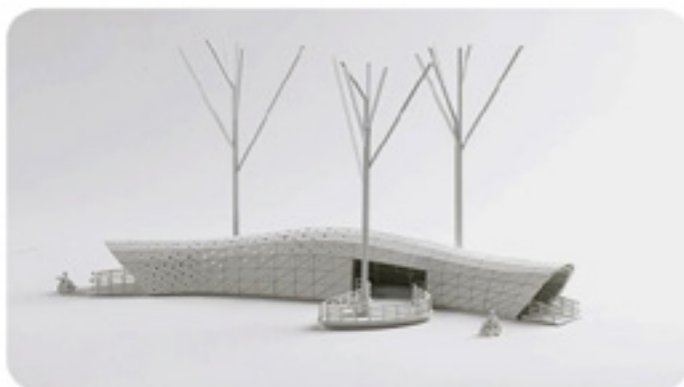



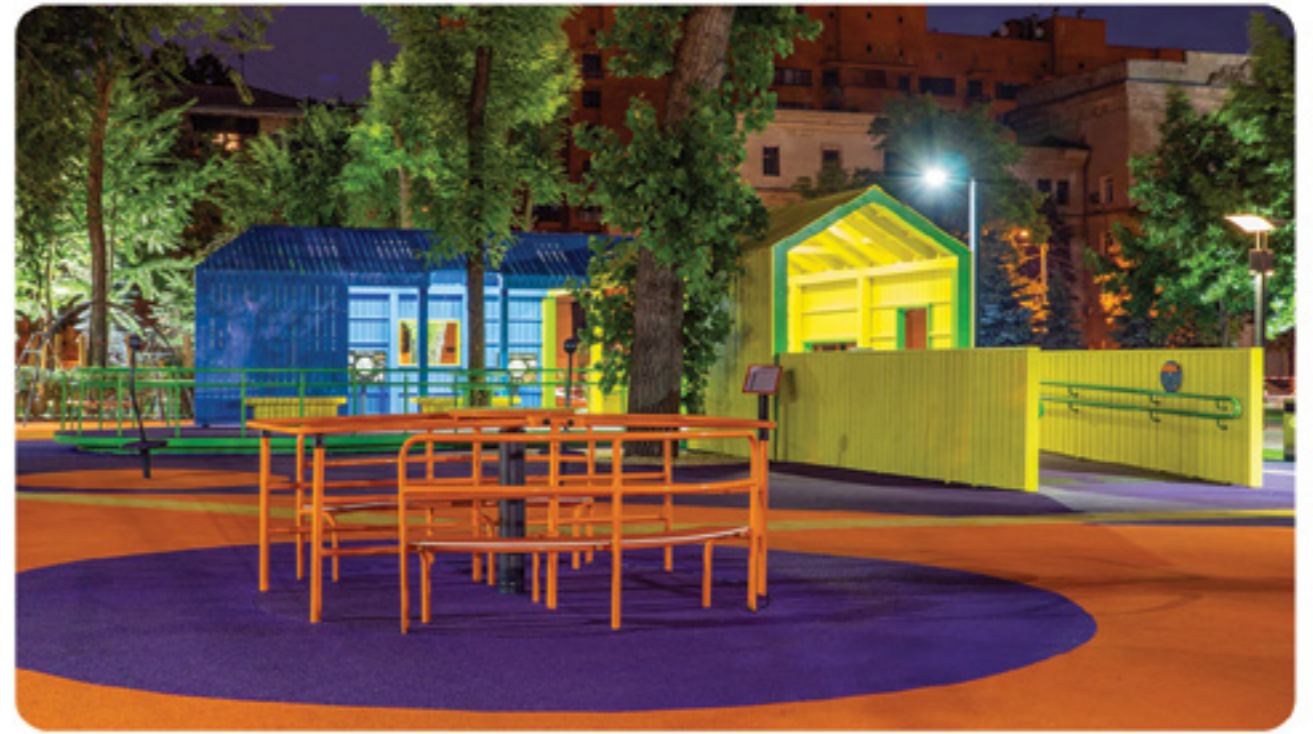



## Проект Президента України «Нове село» / Project of the President of Ukraine «New Village»

Проект «Нове село» президента України спрямований на модернізацію та розвиток сільських територій. Його основна мета – забезпечити села сучасними інфраструктурними рішеннями, підвищити якість життя мешканців та стимулювати економічний розвиток регіонів.

У рамках проекту «Нове село» передбачено створення сучасного дитячого майданчика, який має бути зоною для активного центрального дозвілля та розвитку дітей у сільських громадах. Майданчик обладнаний безпечними та екологічно чистими ігровими конструкціями, які сприяють розвитку фізичних та когнітивних навичок дітей. Крім того, на майданчику створені комфортні умови для батьків та супроводжуючих, щоб забезпечити сприятливу атмосферу.

The President of Ukraine's New Village project is aimed at modernizing and developing rural areas. Its main goal is to provide villages with modern infrastructure solutions, improve the quality of life of residents and stimulate economic development in the regions.

The New Village project provides for the creation of a modern playground, which should be an area for active central entertainment and development of children in rural communities. The playground is equipped with safe and environmentally friendly play structures that promote the development of children's physical and cognitive skills. In addition, the playground has comfortable conditions for parents and accompanying persons to ensure a positive atmosphere.





## Проекти дитячих майданчиків в стилі «Еко»/ Designs of playgrounds in the «Eco» style

Дитячі майданчики в стилі «Еко» – це оазис природи прямо в місті. Вони виготовлені з натуральної деревини, що створює неповторну та теплу атмосферу, де діти можуть безпечно грати та відкриватися для себе в природі.

На цих майданчиках передбачено розмістити зони в гармонійному зв'язку один з одним, враховуючи їх функціональне навантаження; вік, потреби та інтереси відвідувачів. Дотримати баланс між гучними і спокійними зонами, активним рухом і пасивним відпочинком. А також врахувати безбар'єрний доступ до всіх елементів майданчика.

Eco-style playgrounds are an oasis of nature right in the city. They are made of natural wood, which creates a unique and warm atmosphere where children can play safely and discover themselves in nature.

These playgrounds are designed to place zones in harmony with each other, according to their functional load; age, needs and interests of visitors. To keep a balance between noisy and quiet areas, active movement and passive rest. And also include barrier-free access to all elements of the playgrounds.





## Про компанію «Гойда»/ About the company «Goida»

Згуртований колектив співробітників ТМ ГОЙДА - це родина, де дорослі члени її, роблять щоденно дитинство дітях щасливим, адже вони з кожним днем дорослішають.

Дизайнери малюють та винаходять різноманітні елементи для створення дитячих майданчиків.

Конструкторський відділ опрацьовує ці винаходи, та робить конструктив.

Виробництво на всіх його етапах контролює безпеку та якість.

Монтажні бригади - це команда, яка завершує етап від малюнка на папері - до майданчика на вашому подвір'ї.

Менеджери проектів - об'єднують співпрацю кожного підрозділу фірми, та повністю несуть відповідальність перед замовником та споживачем!

The close-knit team of employees of TH GOIDA is a family, where its adult members make children's childhood happy every day, as they grow up every day.

Designers draw and invent various elements to create playgrounds.

The design department works on these inventions and makes the structure.

The production department controls safety and quality at all stages.

Installation crews are the team that completes the stage from a drawing on paper to a playground in your backyard.

Project managers - combine the cooperation of each department of the company, and are fully responsible to the customer and the consumer!





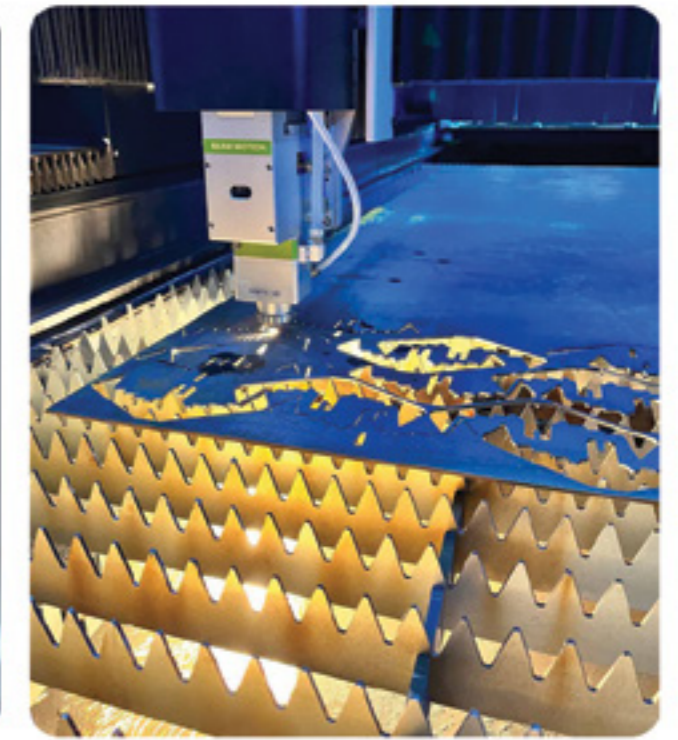





# PRAY FOR UKRAINE

**Кожен дитячий майданчик та МАФ від ТМ ГОЙДА – це результат наших високих стандартів якості, довговічності та безпеки, а також бездоганного дизайну, котрі встановлені більш ніж у 50 країнах світу.**

**Ми пропонуємо широкий асортимент ігрових рішень для дітей будь-якого віку та інтересів, щоб їхнє дитинство стало по-справжньому незабутнім та яскравим.**

*Every children's playground and small architectural forms from TM GOIDA is a result our high standards of quality, durability and safety, as well as impeccable design, which are installed in more than 50 countries of the world.*

*We offer a wide range of play solutions for children of all ages and interests to make their childhood truly unforgettable and bright.*

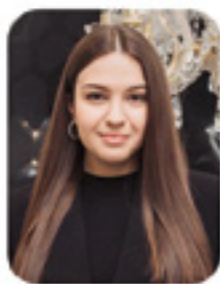

### Dear foreign partners!

For the convenience to cooperate together, in 2020 our company opened a branch of TM Goida in Warsaw (Poland). In the warehouse of the department there are always ready products for shipment. If necessary, a team of professionals will perform a full range of services for you, from design to installation on the object anywhere in Europe. Thank you for your orders, good feedback and help to Ukraine.

☎ +48791778075 (Europe calls)

☎ +380675223738 (WhatsApp, Viber, Telegram)

✉ [poland@goida-da.com](mailto:poland@goida-da.com)